

Series SH/SHG Stainless Steel Hydraulic Cylinders

Catalog HY04-AC1138-4/NA
March, 2013



ATLAS
CYLINDERS

Series SH – Your best value in Heavy Duty Stainless Steel Hydraulic Cylinders

- 316 stainless steel heavy duty hydraulic cylinder construction offers superior corrosion resistance for greater durability in harsh environments
- Integral stainless steel gland-in-head design for longer life than traditional retained style gland materials
- Self-regulating cushions do not require adjustment which reduces set-up cost*

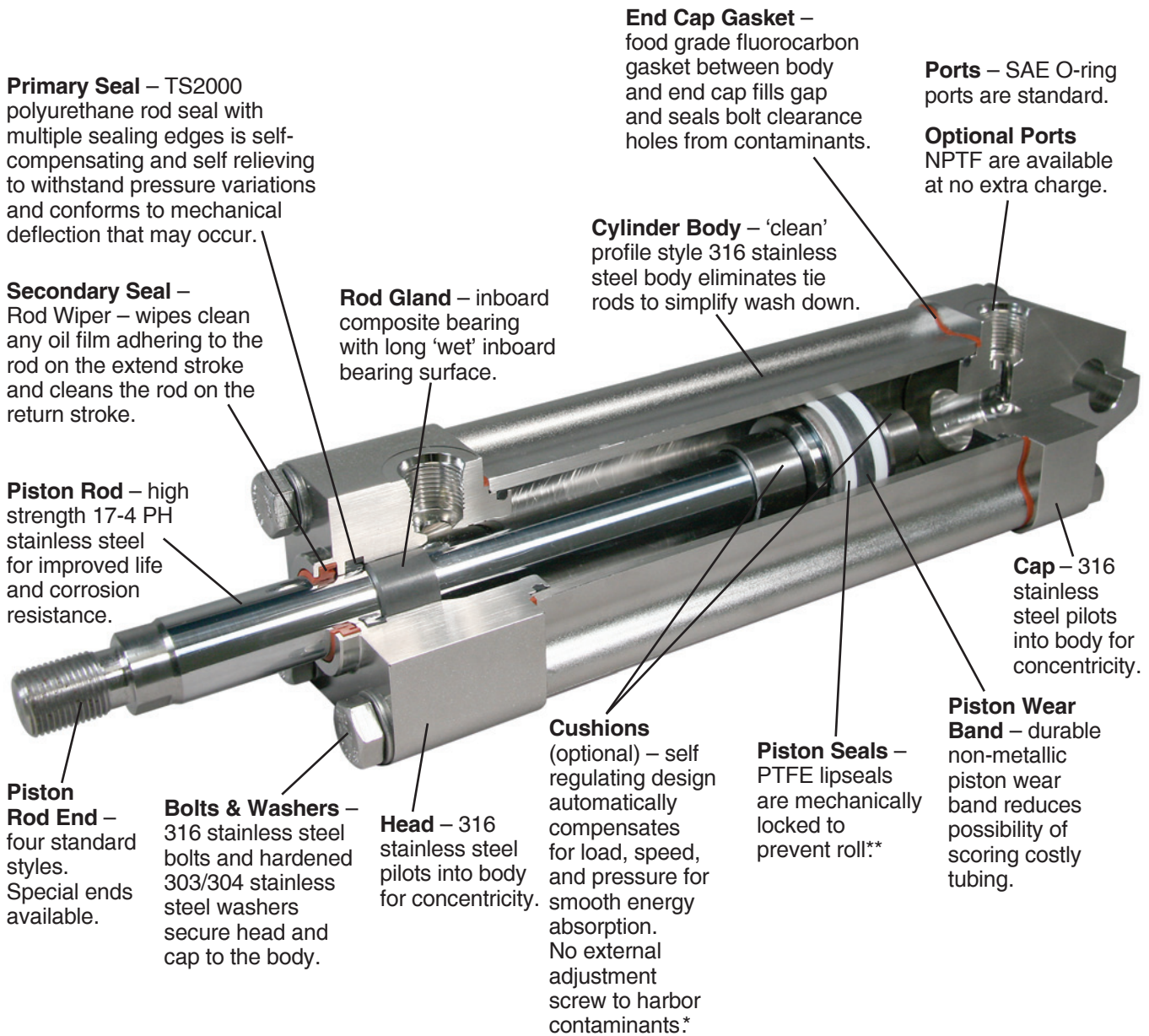

Primary Seal – TS2000 polyurethane rod seal with multiple sealing edges is self-compensating and self relieving to withstand pressure variations and conforms to mechanical deflection that may occur.

Secondary Seal – Rod Wiper – wipes clean any oil film adhering to the rod on the extend stroke and cleans the rod on the return stroke.

Piston Rod – high strength 17-4 PH stainless steel for improved life and corrosion resistance.

Piston Rod End – four standard styles. Special ends available.

Bolts & Washers – 316 stainless steel bolts and hardened 303/304 stainless steel washers secure head and cap to the body.

Rod Gland – inboard composite bearing with long ‘wet’ inboard bearing surface.

Head – 316 stainless steel pilots into body for concentricity.

End Cap Gasket – food grade fluorocarbon gasket between body and end cap fills gap and seals bolt clearance holes from contaminants.

Cylinder Body – ‘clean’ profile style 316 stainless steel body eliminates tie rods to simplify wash down.

Cushions (optional) – self regulating design automatically compensates for load, speed, and pressure for smooth energy absorption. No external adjustment screw to harbor contaminants.*

Piston Seals – PTFE lipseals are mechanically locked to prevent roll**

Ports – SAE O-ring ports are standard.

Optional Ports NPTF are available at no extra charge.

Cap – 316 stainless steel pilots into body for concentricity.

Piston Wear Band – durable non-metallic piston wear band reduces possibility of scoring costly tubing.

* When cushions are specified on 1½", 2", 2½" bores with oversize rod, a fixed cushion without adjusting screw is supplied on the head end. Fixed cushion rate of deceleration is constant and does not vary with load, speed, and pressure like self-regulating style cushions.

** Hi-Load piston is supplied as standard in 1½", 2" and 2½" bores with oversize rod.

Series SHG – Your best value in heavy duty hydraulic cylinders for food processing applications

In addition to features of Series SH cylinders, Series SHG includes exterior surfaces that are electropolished, food grade wiperseal material, Stat-O-Seal™ washers under bolt heads for maximum protection against contamination, and assembly with H-1 rated lubricant.

Series SHG Feature	Benefit	Series SHG Value
<p>Rounded Corners on Head and Cap and “Clean” Profile Body without Tie Rods</p>	<p>Material does not collect around cylinder tie rods or build up on head and cap surfaces.</p> <p>Extruded construction simplifies repairability compared to tie rod style.</p>	<p>Wash down time is reduced with 'clean' profile style body and rounded head and cap corners.</p> <p>Equipment down time for repair is reduced.</p>
<p>Standard PTFE Piston Seals with Non-Metallic Piston Wear Band</p>	<p>PTFE piston seals have greater fluid and temperature resistance than elastomeric seals.</p> <p>Non-metallic wear band for greater protection against scoring costly tubing.</p>	<p>Longer piston seal and tube life than typical cylinders used in food processing applications.</p>
<p>Self-Regulating Cushions</p>	<p>Automatic compensation for load, speed, and pressure ensures optimal cushion performance. Saves manual adjustment labor.</p> <p>No needle or check valve cavities to collect contamination.</p>	<p>Time required for machine set-up, operational adjustments and cleaning is reduced.</p>
<p>Electropolished Cylinder Exterior</p>	<p>Electropolishing significantly improves corrosion resistance and improves surface condition to resist bacteria.</p>	<p>Reduced corrosion increases cylinder life and replacement interval.</p> <p>Added bacterial resistance promotes better food handling practices.</p>
<p>Integral Gland with Food Grade Wiperseal</p>	<p>Integral stainless steel gland with inboard bearing is more corrosion resistant than traditional retained style gland materials. Food grade wiperseal accepts food contact.</p>	<p>Gland service interval is increased which reduces maintenance cost.</p>
<p>USDA H-1 Rated Fluid Used for Cylinder Assembly Lubrication and Testing</p>	<p>Eliminates possibility of hydraulic system contamination by unknown lubricants from the cylinder.</p>	<p>Reduced setup time by eliminating need to purge cylinder.</p>

Table of Contents	Page No.
SH Cylinder Features.....	Inside Front Cover
SHG Cylinder Features.....	1
Model Numbers – How to Develop and Decode Them	3
Standard Specifications	3
Theoretical Output, Maximum Pressures	4
Cylinder Weights	5
T, TB, TC, TD Mount Dimensions – Single Rod End.....	6
T, TB, TD Mount Dimensions – Double Rod End	7
JJ Mount Dimensions – Single Rod End	8
JJ Mount Dimensions – Double Rod End.....	9
HH Mount Dimensions – Single Rod End.....	10
BE Mount Dimensions – Single Rod End	11
F Mount Dimensions – Single Rod End.....	12
F Mount Dimensions – Double Rod End	13
D Mount Dimensions – Single Rod End	14
D Mount Dimensions – Double Rod End.....	15
Mounting Accessories.....	16, 17
Stop Tubing, Mounting Classes	18
Cylinder Stroke Chart.....	19
Parts List.....	20
Thrust Key Mounting.....	20
Parts Identification / Seal Kits	21
Cylinder Safety Guide	22, 23
Offer of Sale.....	24

In line with our policy of continuing product improvement, specifications and information contained in this catalog are subject to change.

Copyright ©2008-2013 by Parker Hannifin Corporation.

All rights reserved.

PRINTED IN THE U.S.A.

 **WARNING**

FAILURE OR IMPROPER SELECTION OR IMPROPER USE OF THE PRODUCTS AND/OR SYSTEMS DESCRIBED HEREIN OR RELATED ITEMS CAN CAUSE DEATH, PERSONAL INJURY AND PROPERTY DAMAGE.

This document and other information from the Parker Hannifin Corporation, its subsidiaries and authorized distributors provide product and/or system options for further investigation by users having expertise. It is important that you analyze all aspects of your application, including consequences of any failure and review the information concerning the product or system in the current product catalog. Due to the variety of operating conditions and applications for these products or systems, the user, through its own analysis and testing, is solely responsible for making the final selection of the products and systems and assuring that all performance, safety and warning requirements of the application are met.

The products described herein, including without limitation, product features, specifications, designs, availability and pricing, are subject to change by Parker Hannifin Corporation and its subsidiaries at any time without notice.

Offer of Sale

The items described in this document are hereby offered for sale by Parker Hannifin Corporation, its subsidiaries or its authorized distributors. This offer and its acceptance are governed by provisions stated on a separate page of the document entitled 'Offer of Sale'.

Model Code & Standard Specifications

Model Ordering Code for SH and SHG

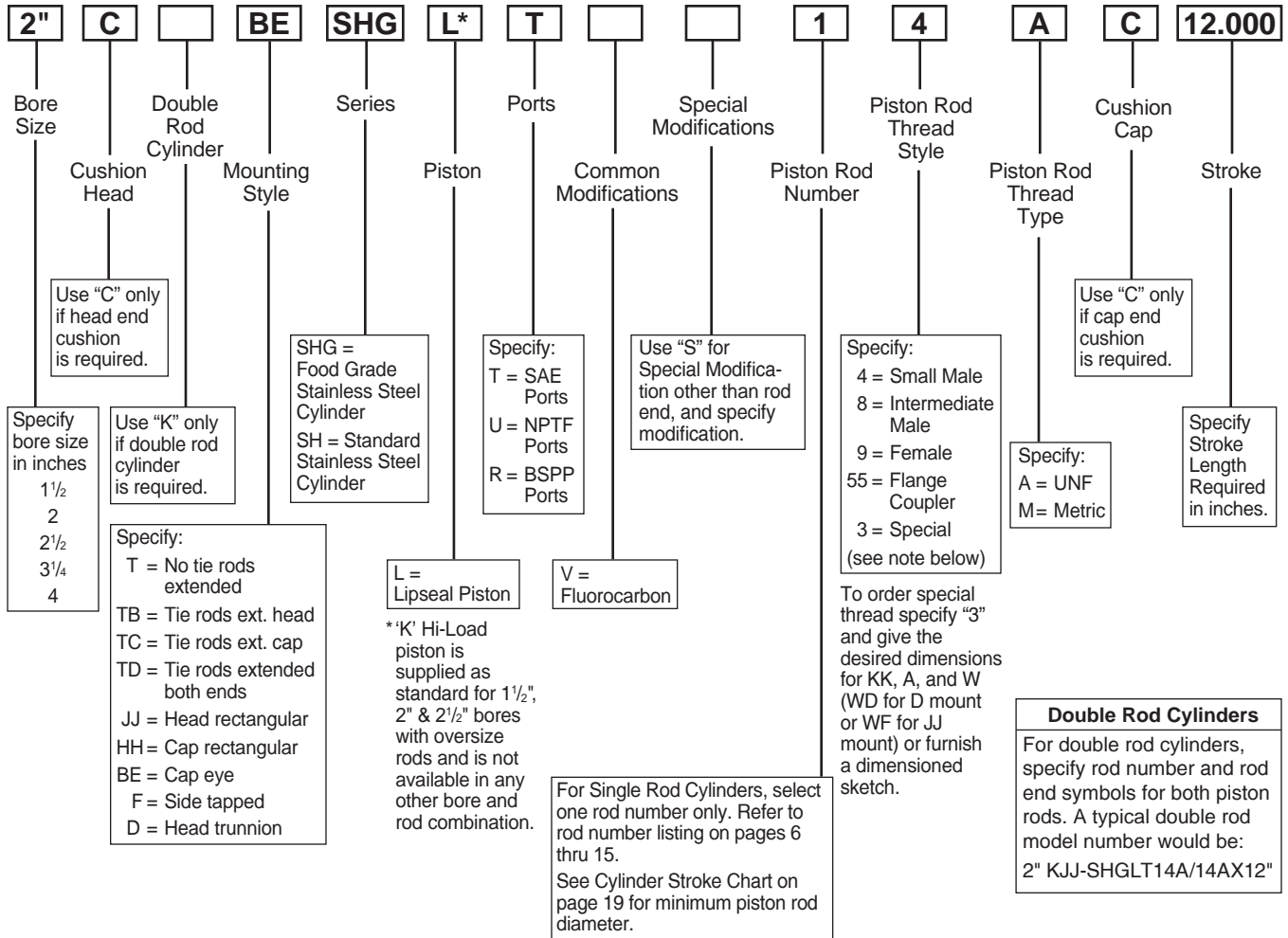

Standard Specifications

- 6 Standard mounting styles
- Bore sizes – 1 1/2" to 4"
- Strokes – up to 72"
- Piston Rod Diameters – 5/8" to 2 1/2"
- Working pressure up to 3000 psi
- Single and double rod construction available
- Temperature range – -10°F (-23°C) to +250°F (+121°C) (depending on seal class)

Seal Classes	Typical Fluids	Temperature Range
1 – Standard Nitrile, Polyurethane & PTFE	ISO Grade 32 NSF / USDA H-1 Oils (Acceptable for use in Food Industry) – Approved products include Chevron FM32, Petro-Canada Purity FG AW32, Mobil DTE FM32, ConocoPhillips 200 Hydraulic Oil, MIL-H-5606 Oil	-10°F (-23°C) to +165°F (+74°C)
5 – Optional (At extra cost) Fluorocarbon Seals	High Temperature	-10°F (-23°C) to +250°F (+121°C) Class 5 seals may be operated up to +400°F (+204°C) with reduced service life

Note: Class 5 seals are not suitable for use with Skydrol fluid, but can be used with hydraulic oil if desired.
Rod seal, wiperseal, and body o-rings are fluorocarbon; piston seals are spring loaded PTFE.
Contact the factory before specifying Series SH or SHG for use with phosphate ester fluid.

Theoretical Push and Pull Forces

The cylinder output forces are derived from this formula:

$$F = P \times A$$

Where F = Force in pounds.

P = Pressure at the cylinder in pounds per square inch.

A = Effective area of cylinder piston in square inches.

To determine the bore size for the application, follow the steps below.

1. Select the Operating Pressure column closest to that desired.
2. In the same column, identify the force required to move the load (always rounding up). If the piston rod is in compression use the 'Push' row and if the piston rod is in tension use the 'Pull' row.
3. In the row to the left is the bore required. To select the correct rod diameter for the stroke required use the Piston Rod-Stroke Selection Chart on page 19.

If the cylinder envelope dimensions are too large for the application, increase the operating pressure to the maximum pressure in the table below, if possible, and repeat steps 1 - 3.

Pressure Ratings

Series SH and SHG hydraulic cylinders are recommended for pressures to **3000 psi** for heavy-duty hydraulic service with hydraulic oil.

Maximum Pressure Ratings

Bore Ø	Rod Ø	Heavy Duty Service (psi)
1 1/2	5/8, 1	3000
2	1, 1 3/8	3000
2 1/2	1, 1 3/4	3000
3 1/4	1 3/8, 2	3000
4	1 3/4, 2 1/2	3000

Push and Pull Force in Pounds

Bore Ø	Rod Ø	Operating Direction	Piston Area (inches ²)	Operating Pressure in psi					
				100	250	500	1000	2000	3000
1 1/2	5/8	Push	1.767	177	442	884	1767	3534	5301
		Pull	1.460	146	365	730	1460	2920	4380
	1	Push	1.767	177	442	884	1767	3534	5301
		Pull	0.982	98	246	491	982	1964	2946
2	1	Push	3.142	314	786	1571	3142	6284	9426
		Pull	2.357	236	589	1179	2357	4714	7071
	1 3/8	Push	3.142	314	786	1571	3142	6284	9426
		Pull	1.652	165	413	826	1652	3304	4956
2 1/2	1	Push	4.909	491	1227	2455	4909	9818	14727
		Pull	4.124	412	1031	2062	4124	8248	12372
	1 3/4	Push	4.909	491	1227	2455	4909	9818	14727
		Pull	2.499	250	625	1250	2499	4998	7497
3 1/4	1 3/8	Push	8.296	830	2074	4148	8296	16592	24888
		Pull	6.806	681	1702	3403	6806	13612	20418
	2	Push	8.296	830	2074	4148	8296	16592	24888
		Pull	5.154	515	1289	2577	5154	10308	15462
4	1 3/4	Push	12.566	1257	3142	6283	12566	25132	37698
		Pull	10.156	1016	2539	5078	10156	20312	30468
	2 1/2	Push	12.566	1257	3142	6283	12566	25132	37698
		Pull	7.656	766	1914	3828	7656	15312	22968

Cylinder Weights

To determine the weight of a Series SH or SHG cylinder, first select the basic zero stroke weight for the mounting required, and then calculate the weight of the

cylinder stroke and add the results to the basic weight. For extra rod extension, use piston rod weights per inch in Table C.

Table A – Single Rod End SH & SHG Cylinder Weights in Pounds

Bore Ø	Rod Ø	Single Rod Cylinders Basic Weight - Zero Stroke					Add Per Inch of Stroke
		T, TB, TC, TD, F	JJ	D	BE	HH	
1 1/2	5/8	7.3	9.1	7.8	7.7	8.4	0.7
	1	8.2	10.0	8.6	8.6	9.3	0.8
2	1	11.8	14.8	13.1	12.9	13.4	1.1
	1 3/8	13.3	16.3	14.5	14.4	14.8	1.3
2 1/2	1	17.1	20.7	18.3	18.6	19.0	1.6
	1 3/4	20.7	24.3	21.9	22.2	22.6	2.0
3 1/4	1 3/8	33.5	40.2	36.0	36.3	37.1	2.4
	2	37.6	44.4	40.2	40.5	41.2	2.9
4	1 3/4	45.8	53.8	48.2	51.8	49.9	3.2
	2 1/2	53.4	61.4	55.8	59.4	57.5	3.9

Table B – Double Rod End SH & SHG Cylinder Weights in Pounds

Bore Ø	Rod Ø	Double Rod Cylinders Basic Weight - Zero Stroke			Add Per Inch of Stroke
		KT, KTB, KTD, KF	KJJ	KD	
1 1/2	5/8	8.7	10.5	9.2	0.8
	1	10.5	12.3	11.0	1.1
2	1	14.7	17.7	16.0	1.3
	1 3/8	17.6	20.6	18.8	1.7
2 1/2	1	20.8	24.4	22.1	1.8
	1 3/4	28.0	31.6	29.2	2.7
3 1/4	1 3/8	40.8	47.6	43.4	2.8
	2	49.2	55.9	51.7	3.8
4	1 3/4	56.9	65.0	59.3	3.9
	2 1/2	72.1	80.2	74.5	5.3

Table C – Piston Rod Weights in Pounds

Rod Ø	Piston Rod Weight Per Inch
5/8	0.09
1	0.22
1 3/8	0.42
1 3/4	0.68
2	0.89
2 1/2	1.40

TD Mount – Single Rod End*

1 1/2" to 4" Bore Size

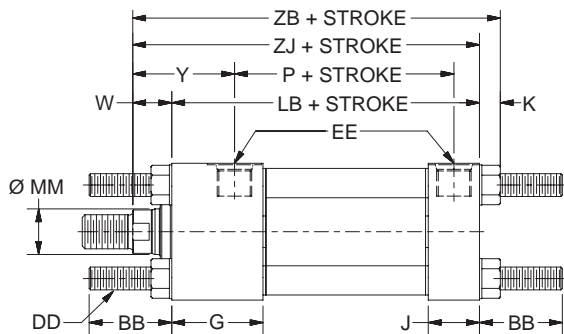
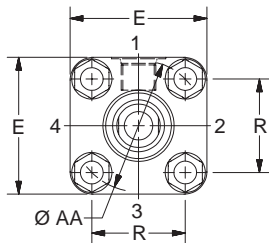
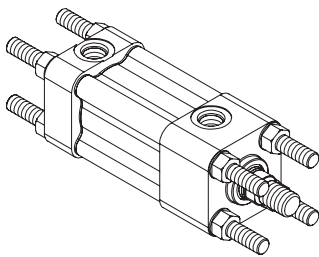

T, TB, TC, TD Mount Single Rod End – Envelope and Mounting Dimensions

Bore Ø	AA	BB	DD	E	EE		G	J	K Max	R	Add Stroke	
					NPTF	SAE					LB	P
1 1/2	2.3	1 3/8	3/8-24	2 1/2	1/2	8	1 3/4	1 1/8	7/16	1.63	5	3 1/4
2	2.9	1 13/16	1/2-20	3	1/2	8	2	1 1/8	1/2	2.05	5 1/4	3 5/16
2 1/2	3.6	1 13/16	1/2-20	3 1/2	1/2	8	2	1 1/8	1/2	2.55	5 3/8	3 7/16
3 1/4	4.6	2 5/16	5/8-18	4 1/2	3/4	10	2 3/8	1 3/8	5/8	3.25	6 1/4	3 15/16
4	5.4	2 5/16	5/8-18	5	3/4	12	2 1/2	1 3/8	5/8	3.82	6 5/8	4 1/4

T, TB, TC, TD Mount Single Rod End – Rod Dimensions

Bore Ø	Rod No.	MM Rod Ø	Rod Extensions and Pilot Dimensions											
			A	AD	AE	AF	AM	B +.000 -.002	C	D	NA	V	W	WH
1 1/2	1	5/8	3/4	5/8	1/4	3/8	0.57	1.124	3/8	1/2	9/16	1/4	5/8	3/4
	2	1	1 1/8	15/16	3/8	11/16	0.95	1.499	1/2	7/8	15/16	1/2	1	1 1/16
2	1	1	1 1/8	15/16	3/8	11/16	0.95	1.499	1/2	7/8	15/16	1/4	3/4	13/16
	2	1 3/8	1 5/8	1 1/16	3/8	7/8	1.32	1.999	5/8	1 1/8	1 5/16	3/8	1	1 1/16
2 1/2	1	1	1 1/8	15/16	3/8	11/16	0.95	1.499	1/2	7/8	15/16	1/4	3/4	13/16
	2	1 3/4	2	1 5/16	1/2	1 1/8	1.70	2.374	3/4	1 1/2	1 11/16	1/2	1 1/4	1 3/16
3 1/4	1	1 3/8	1 5/8	1 1/16	3/8	7/8	1.32	1.999	5/8	1 1/8	1 5/16	1/4	7/8	15/16
	2	2	2 1/4	1 11/16	5/8	1 3/8	1.95	2.624	7/8	1 11/16	1 15/16	3/8	1 1/4	1 5/16
4	1	1 3/4	2	1 5/16	1/2	1 1/8	1.70	2.374	3/4	1 1/2	1 11/16	1/4	1	15/16
	2	2 1/2	3	1 15/16	3/4	1 3/4	2.45	3.124	1	2 1/16	2 3/8	3/8	1 3/8	1 11/16

Bore Ø	Rod No.	MM Rod Ø	Thread		Y	Add Stroke	
			Style 8 CC	Style 4 & 9 KK		ZB	ZJ
1 1/2	1	5/8	1/2-20	7/16-20	1 13/16	6 1/16	5 5/8
	2	1	7/8-14	3/4-16	2 3/16	6 7/16	6
2	1	1	7/8-14	3/4-16	2 1/8	6 1/2	6
	2	1 3/8	1 1/4-12	1-14	2 3/8	6 3/4	6 1/4
2 1/2	1	1	7/8-14	3/4-16	2 1/8	6 5/8	6 1/8
	2	1 3/4	1 1/2-12	1 1/4-12	2 5/8	7 1/8	6 5/8

Bore Ø	Rod No.	MM Rod Ø	Thread		Y	Add Stroke	
			Style 8 CC	Style 4 & 9 KK		ZB	ZJ
3 1/4	1	1 3/8	1 1/4-12	1-14	2 1/2	7 3/4	7 1/8
	2	2	1 3/4-12	1 1/2-12	2 7/8	8 1/8	7 1/2
4	1	1 3/4	1 1/2-12	1 1/4-12	2 11/16	8 1/4	7 5/8
	2	2 1/2	2 1/4-12	1 7/8-12	3 1/16	8 5/8	8

*Style T – no tie rods extended, Style TB – tie rods extended head end, and Style TC – tie rods extended cap end can be dimensioned from Style TD shown.

Rod End Dimensions

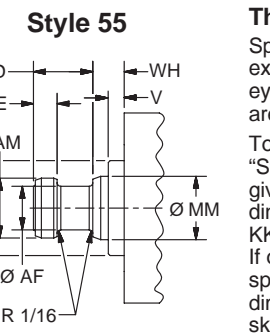
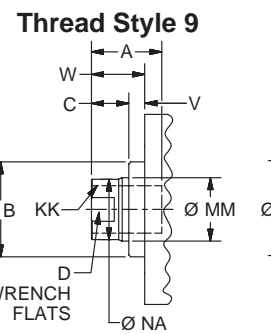
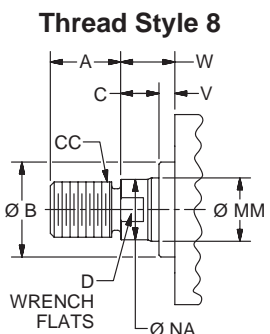
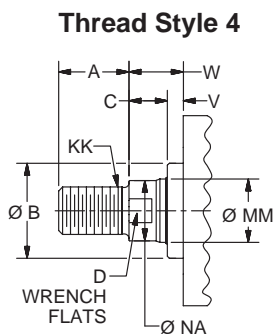

“Special” Thread Style 3
Special thread, extension, rod eye, blank, etc. are also available. To order, specify “Style 3” and give desired dimensions for KK, A, & W. If otherwise special furnish dimensional sketch.

TD Mount – Double Rod End*

1 1/2" to 4" Bore Size

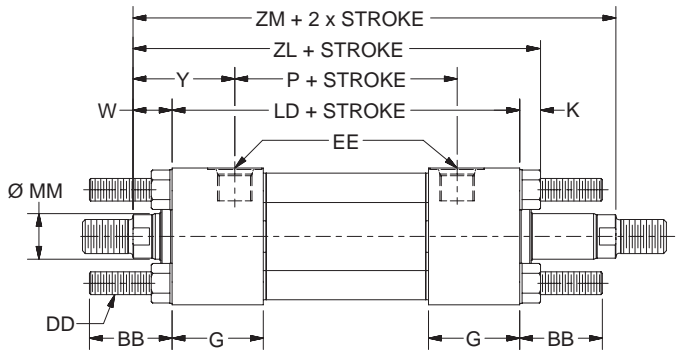
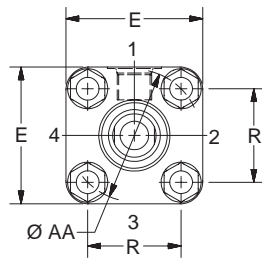
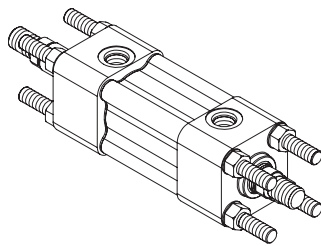

T, TB, TD Mount Double Rod End – Envelope and Mounting Dimensions

Bore Ø	AA	BB	DD	E	EE		G	K Max	R	Add Stroke	
					NPTF	SAE				LD	P
1 1/2	2.3	1 3/8	3/8-24	2 1/2	1/2	8	1 3/4	7/16	1.63	5 5/8	3 1/4
2	2.9	1 13/16	1/2-20	3	1/2	8	2	1/2	2.05	6 1/8	3 3/8
2 1/2	3.6	1 13/16	1/2-20	3 1/2	1/2	8	2	1/2	2.55	6 1/4	3 1/2
3 1/4	4.6	2 5/16	5/8-18	4 1/2	3/4	10	2 3/8	5/8	3.25	7 1/4	4
4	5.4	2 5/16	5/8-18	5	3/4	12	2 1/2	5/8	3.82	7 3/4	4 3/8

T, TB, TD Mount Double Rod End – Rod Dimensions

Bore Ø	Rod No.	MM Rod Ø	Rod Extensions and Pilot Dimensions											
			A	AD	AE	AF	AM	B +.000 -.002	C	D	NA	V	W	WH
1 1/2	1	5/8	3/4	5/8	1/4	3/8	0.57	1.124	3/8	1/2	9/16	1/4	5/8	3/4
	2	1	1 1/8	15/16	3/8	11/16	0.95	1.499	1/2	7/8	15/16	1/2	1	1 1/16
2	1	1	1 1/8	15/16	3/8	11/16	0.95	1.499	1/2	7/8	15/16	1/4	3/4	13/16
	2	1 3/8	1 5/8	1 1/16	3/8	7/8	1.32	1.999	5/8	1 1/8	1 5/16	3/8	1	1 1/16
2 1/2	1	1	1 1/8	15/16	3/8	11/16	0.95	1.499	1/2	7/8	15/16	1/4	3/4	13/16
	2	1 3/4	2	1 5/16	1/2	1 1/8	1.70	2.374	3/4	1 1/2	1 11/16	1/2	1 1/4	1 3/16
3 1/4	1	1 3/8	1 5/8	1 1/16	3/8	7/8	1.32	1.999	5/8	1 1/8	1 5/16	1/4	7/8	15/16
	2	2	2 1/4	1 11/16	5/8	1 3/8	1.95	2.624	7/8	1 11/16	1 15/16	3/8	1 1/4	1 5/16
4	1	1 3/4	2	1 5/16	1/2	1 1/8	1.70	2.374	3/4	1 1/2	1 11/16	1/4	1	15/16
	2	2 1/2	3	1 15/16	3/4	1 3/4	2.45	3.124	1	2 1/16	2 3/8	3/8	1 3/8	1 11/16

Bore Ø	Rod No.	MM Rod Ø	Thread		Y	Add Stroke	
			Style 8 CC	Style 4 & 9 KK		ZL	ZM
1 1/2	1	5/8	1/2-20	7/16-20	1 13/16	6 11/16	6 7/8
	2	1	7/8-14	3/4-16	2 3/16	7 1/16	7 5/8
2	1	1	7/8-14	3/4-16	2 1/8	7 3/8	7 5/8
	2	1 3/8	1 1/4-12	1-14	2 3/8	7 5/8	8 1/8
2 1/2	1	1	7/8-14	3/4-16	2 1/8	7 1/2	7 3/4
	2	1 3/4	1 1/2-12	1 1/4-12	2 5/8	8	8 3/4

Bore Ø	Rod No.	MM Rod Ø	Thread		Y	Add Stroke	
			Style 8 CC	Style 4 & 9 KK		ZL	ZM
3 1/4	1	1 3/8	1 1/4-12	1-14	2 1/2	8 3/4	9
	2	2	1 3/4-12	1 1/2-12	2 7/8	9 1/8	9 3/4
4	1	1 3/4	1 1/2-12	1 1/4-12	2 11/16	9 3/8	9 3/4
	2	2 1/2	2 1/4-12	1 7/8-12	3 1/16	9 3/4	10 1/2

* Style T – no tie rods extended and Style TB – tie rods extended one end can be dimensioned from Style TD shown.

Rod End Dimensions

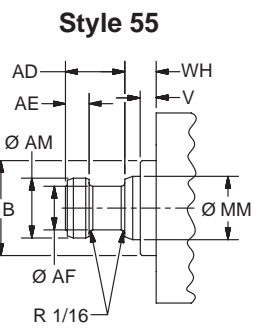
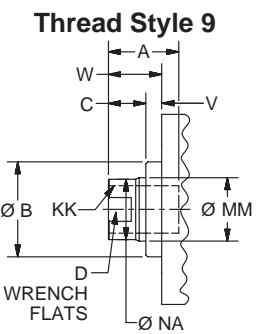
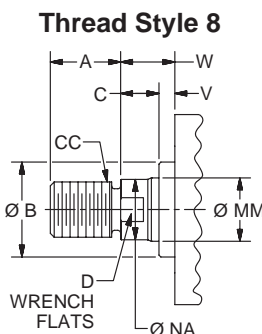
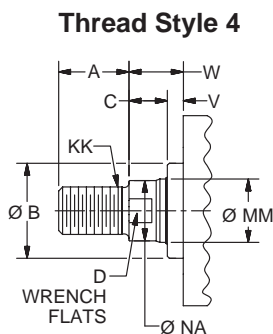

“Special” Thread Style 3
Special thread, extension, rod eye, blank, etc. are also available. To order, specify “Style 3” and give desired dimensions for KK, A, & W. If otherwise special furnish dimensional sketch.

JJ Mount – Single Rod End

1 1/2" to 4" Bore Size

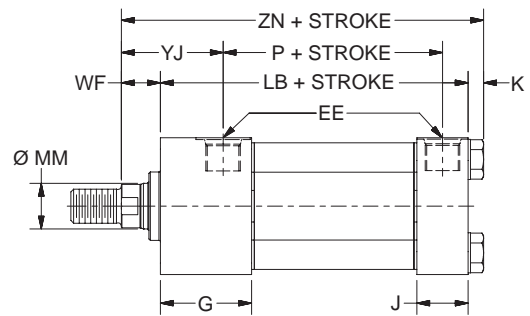
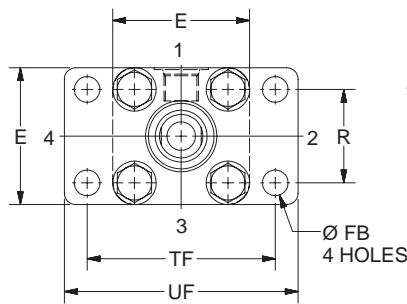
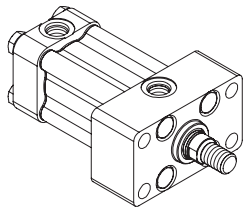

JJ Mount Single Rod End – Envelope and Mounting Dimensions

Bore Ø	E	EE		FB	G	J	K Max	R	TF	UF	Add Stroke	
		NPTF	SAE								LB	P
1 1/2	2 1/2	1/2	8	7/16	1 3/4	1 1/8	7/16	1.63	3 7/16	4 1/4	5	3 1/4
2	3	1/2	8	9/16	2	1 1/8	1/2	2.05	4 1/8	5 1/8	5 1/4	3 5/16
2 1/2	3 1/2	1/2	8	9/16	2	1 1/8	1/2	2.55	4 5/8	5 5/8	5 3/8	3 7/16
3 1/4	4 1/2	3/4	10	11/16	2 3/8	1 3/8	5/8	3.25	5 7/8	7 1/8	6 1/4	3 15/16
4	5	3/4	12	11/16	2 1/2	1 3/8	5/8	3.82	6 3/8	7 5/8	6 5/8	4 1/4

JJ Mount Single Rod End – Rod Dimensions

Bore Ø	Rod No.	MM Rod Ø	Rod Extensions and Pilot Dimensions											
			A	AD	AE	AF	AM	B +0.000 -0.002	C	D	NA	V	WF	WK
1 1/2	1	5/8	3/4	5/8	1/4	3/8	0.57	1.124	3/8	1/2	9/16	1/4	1	1 1/8
	2	1	1 1/8	15/16	3/8	11/16	0.95	1.499	1/2	7/8	15/16	1/2	1 3/8	1 7/16
2	1	1	1 1/8	15/16	3/8	11/16	0.95	1.499	1/2	7/8	15/16	1/4	1 3/8	1 7/16
	2	1 3/8	1 5/8	1 1/16	3/8	7/8	1.32	1.999	5/8	1 1/8	1 5/16	3/8	1 5/8	1 11/16
2 1/2	1	1	1 1/8	15/16	3/8	11/16	0.95	1.499	1/2	7/8	15/16	1/4	1 3/8	1 7/16
	2	1 3/4	2	1 5/16	1/2	1 1/8	1.70	2.374	3/4	1 1/2	1 11/16	1/2	1 7/8	1 13/16
3 1/4	1	1 3/8	1 5/8	1 1/16	3/8	7/8	1.32	1.999	5/8	1 1/8	1 5/16	1/4	1 5/8	1 11/16
	2	2	2 1/4	1 11/16	5/8	1 3/8	1.95	2.624	7/8	1 11/16	1 15/16	3/8	2	2 1/16
4	1	1 3/4	2	1 5/16	1/2	1 1/8	1.70	2.374	3/4	1 1/2	1 11/16	1/4	1 7/8	1 13/16
	2	2 1/2	3	1 15/16	3/4	1 3/4	2.45	3.124	1	2 1/16	2 3/8	3/8	2 1/4	2 9/16

Bore Ø	Rod No.	MM Rod Ø	Thread		YJ	Add Stroke ZN
			Style 8 CC	Style 4 & 9 KK		
1 1/2	1	5/8	1/2-20	7/16-20	2 3/16	6 7/16
	2	1	7/8-14	3/4-16	2 9/16	6 13/16
2	1	1	7/8-14	3/4-16	2 3/4	7 1/8
	2	1 3/8	1 1/4-12	1-14	3	7 3/8
2 1/2	1	1	7/8-14	3/4-16	2 3/4	7 1/4
	2	1 3/4	1 1/2-12	1 1/4-12	3 1/4	7 3/4

Bore Ø	Rod No.	MM Rod Ø	Thread		YJ	Add Stroke ZN
			Style 8 CC	Style 4 & 9 KK		
3 1/4	1	1 3/8	1 1/4-12	1-14	3 1/4	8 1/2
	2	2	1 3/4-12	1 1/2-12	3 5/8	8 7/8
4	1	1 3/4	1 1/2-12	1 1/4-12	3 9/16	9 1/8
	2	2 1/2	2 1/4-12	1 7/8-12	3 15/16	9 1/2

Rod End Dimensions

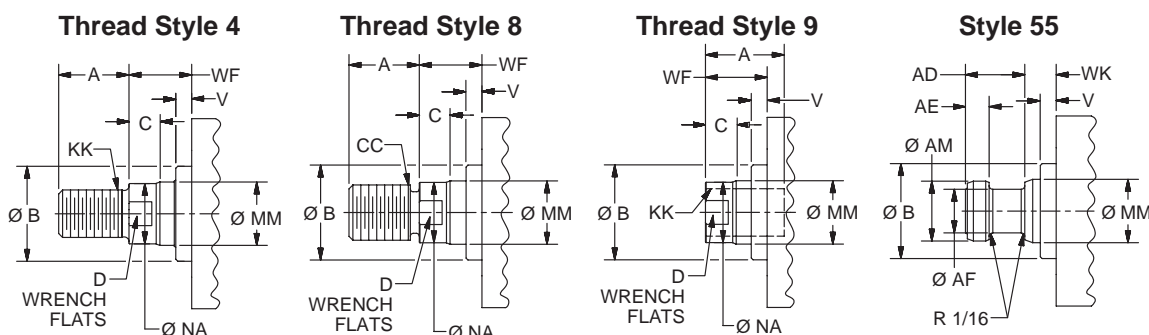

“Special” Thread Style 3
Special thread, extension, rod eye, blank, etc. are also available. To order, specify “Style 3” and give desired dimensions for KK, A, & WF. If otherwise special furnish dimensional sketch.

JJ Mount – Double Rod End

Heavy-Duty Stainless Steel Hydraulic Cylinders Series SH/SHG

JJ Mount – Double Rod End

1 1/2" to 4" Bore Size

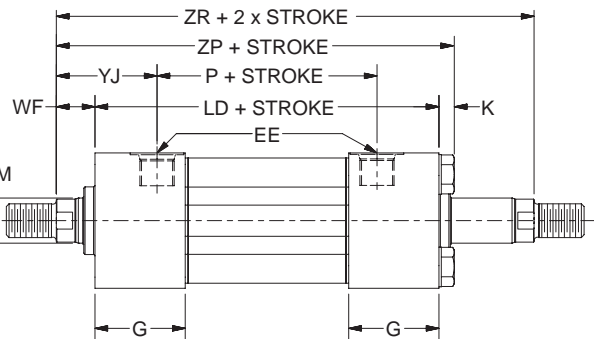
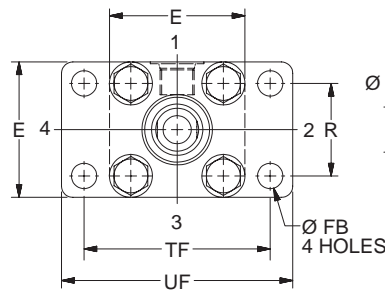
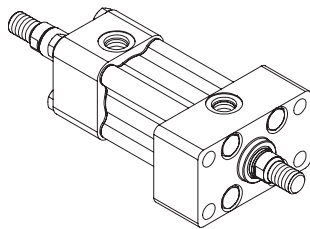

JJ Mount Double Rod End – Envelope and Mounting Dimensions

Bore Ø	E	EE		FB	G	K Max	R	TF	UF	Add Stroke	
		NPTF	SAE							LD	P
1 1/2	2 1/2	1/2	8	7/16	1 3/4	7/16	1.63	3 7/16	4 1/4	5 5/8	3 1/4
2	3	1/2	8	9/16	2	1/2	2.05	4 1/8	5 1/8	6 1/8	3 3/8
2 1/2	3 1/2	1/2	8	9/16	2	1/2	2.55	4 5/8	5 5/8	6 1/4	3 1/2
3 1/4	4 1/2	3/4	10	11/16	2 3/8	5/8	3.25	5 7/8	7 1/8	7 1/4	4
4	5	3/4	12	11/16	2 1/2	5/8	3.82	6 3/8	7 5/8	7 3/4	4 3/8

JJ Mount Double Rod End – Rod Dimensions

Bore Ø	Rod No.	MM Rod Ø	Rod Extensions and Pilot Dimensions											
			A	AD	AE	AF	AM	B +.000 -.002	C	D	NA	V	WF	WK
1 1/2	1	5/8	3/4	5/8	1/4	3/8	0.57	1.124	3/8	1/2	9/16	1/4	1	1 1/8
	2	1	1 1/8	15/16	3/8	11/16	0.95	1.499	1/2	7/8	15/16	1/2	1 3/8	1 7/16
2	1	1	1 1/8	15/16	3/8	11/16	0.95	1.499	1/2	7/8	15/16	1/4	1 3/8	1 7/16
	2	1 3/8	1 5/8	1 1/16	3/8	7/8	1.32	1.999	5/8	1 1/8	1 5/16	3/8	1 5/8	1 11/16
2 1/2	1	1	1 1/8	15/16	3/8	11/16	0.95	1.499	1/2	7/8	15/16	1/4	1 3/8	1 7/16
	2	1 3/4	2	1 5/16	1/2	1 1/8	1.70	2.374	3/4	1 1/2	1 11/16	1/2	1 7/8	1 13/16
3 1/4	1	1 3/8	1 5/8	1 1/16	3/8	7/8	1.32	1.999	5/8	1 1/8	1 5/16	1/4	1 5/8	1 11/16
	2	2	2 1/4	1 11/16	5/8	1 3/8	1.95	2.624	7/8	1 11/16	1 15/16	3/8	2	2 1/16
4	1	1 3/4	2	1 5/16	1/2	1 1/8	1.70	2.374	3/4	1 1/2	1 11/16	1/4	1 7/8	1 13/16
	2	2 1/2	3	1 15/16	3/4	1 3/4	2.45	3.124	1	2 1/16	2 3/8	3/8	2 1/4	2 9/16

Bore Ø	Rod No.	MM Rod Ø	Thread		YJ	Add Stroke		Add 2X Stroke	
			Style 8 CC	Style 4 & 9 KK		ZP	ZR	ZP	ZR
1 1/2	1	5/8	1/2-20	7/16-20	2 3/16	7 1/16	7 1/4		
	2	1	7/8-14	3/4-16	2 9/16	7 7/16	8		
2	1	1	7/8-14	3/4-16	2 3/4	8	8 1/4		
	2	1 3/8	1 1/4-12	1-14	3	8 1/4	8 3/4		
2 1/2	1	1	7/8-14	3/4-16	2 3/4	8 1/8	8 3/8		
	2	1 3/4	1 1/2-12	1 1/4-12	3 1/4	8 5/8	9 3/8		

Bore Ø	Rod No.	MM Rod Ø	Thread		YJ	Add Stroke		Add 2X Stroke	
			Style 8 CC	Style 4 & 9 KK		ZP	ZR	ZP	ZR
3 1/4	1	1 3/8	1 1/4-12	1-14	3 1/4	9 1/2	9 3/4		
	2	2	1 3/4-12	1 1/2-12	3 5/8	9 7/8	10 1/2		
4	1	1 3/4	1 1/2-12	1 1/4-12	3 9/16	10 1/4	10 5/8		
	2	2 1/2	2 1/4-12	1 7/8-12	3 15/16	10 5/8	11 3/8		

Rod End Dimensions

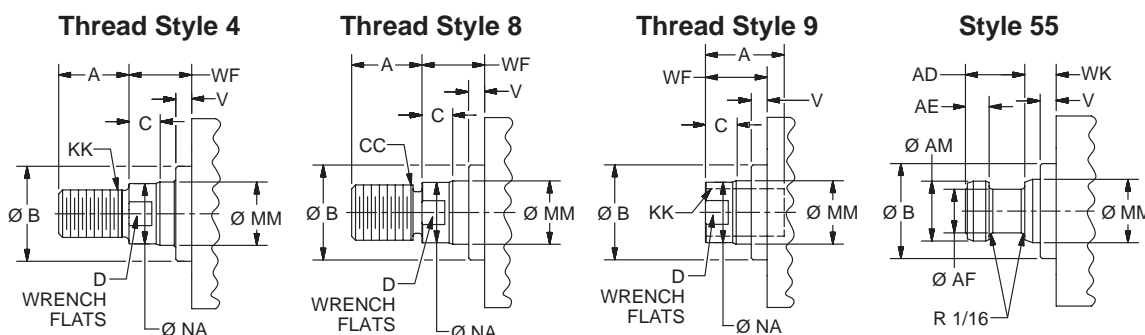

“Special” Thread Style 3
Special thread, rod eye, blank, etc. are also available. To order, specify “Style 3” and give desired dimensions for KK, A, & WF. If otherwise special furnish dimensional sketch.

HH Mount – Single Rod End

1 1/2" to 4" Bore Size

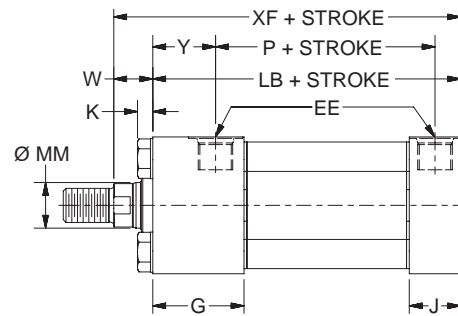
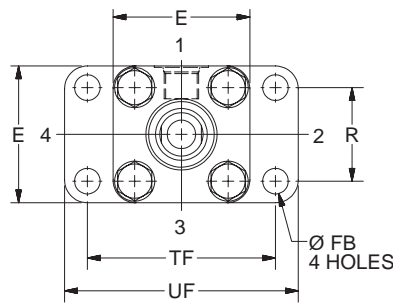
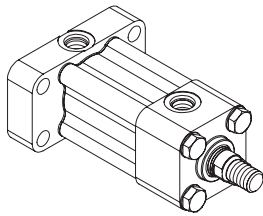

HH Mount Single Rod End – Envelope and Mounting Dimensions

Bore	E	EE		FB	G	J	Max K	R	TF	UF	Add Stroke	
		NPTF	SAE								LB	P
1 1/2	2 1/2	1/2	8	7/16	1 3/4	1 1/8	7/16	1.63	3 7/16	4 1/4	5	3 1/4
2	3	1/2	8	9/16	2	1 1/8	1/2	2.05	4 1/8	5 1/8	5 1/4	3 5/16
2 1/2	3 1/2	1/2	8	9/16	2	1 1/8	1/2	2.55	4 5/8	5 5/8	5 3/8	3 7/16
3 1/4	4 1/2	3/4	10	11/16	2 3/8	1 3/8	5/8	3.25	5 7/8	7 1/8	6 1/4	3 15/16
4	5	3/4	12	11/16	2 1/2	1 3/8	5/8	3.82	6 3/8	7 5/8	6 5/8	4 1/4

HH Mount Single Rod End – Rod Dimensions

Bore Ø	Rod No.	MM Rod Ø	Rod Extensions and Pilot Dimensions											
			A	AD	AE	AF	AM	B +.000 -.002	C	D	NA	V	W	WH
1 1/2	1	5/8	3/4	5/8	1/4	3/8	0.57	1.124	3/8	1/2	9/16	1/4	5/8	3/4
	2	1	1 1/8	15/16	3/8	11/16	0.95	1.499	1/2	7/8	15/16	1/2	1	1 1/16
2	1	1	1 1/8	15/16	3/8	11/16	0.95	1.499	1/2	7/8	15/16	1/4	3/4	13/16
	2	1 3/8	1 5/8	1 1/16	3/8	7/8	1.32	1.999	5/8	1 1/8	1 5/16	3/8	1	1 1/16
2 1/2	1	1	1 1/8	15/16	3/8	11/16	0.95	1.499	1/2	7/8	15/16	1/4	3/4	13/16
	2	1 3/4	2	1 5/16	1/2	1 1/8	1.70	2.374	3/4	1 1/2	1 11/16	1/2	1 1/4	1 3/16
3 1/4	1	1 3/8	1 5/8	1 1/16	3/8	7/8	1.32	1.999	5/8	1 1/8	1 5/16	1/4	7/8	15/16
	2	2	2 1/4	1 11/16	5/8	1 3/8	1.95	2.624	7/8	1 11/16	1 15/16	3/8	1 1/4	1 5/16
4	1	1 3/4	2	1 5/16	1/2	1 1/8	1.70	2.374	3/4	1 1/2	1 11/16	1/4	1	15/16
	2	2 1/2	3	1 15/16	3/4	1 3/4	2.45	3.124	1	2 1/16	2 3/8	3/8	1 3/8	1 11/16

Bore Ø	Rod No.	MM Rod Ø	Thread		Y	Add Stroke XF
			Style 8 CC	Style 4 & 9 KK		
1 1/2	1	5/8	1/2-20	7/16-20	1 13/16	5 5/8
	2	1	7/8-14	3/4-16	2 3/16	6
2	1	1	7/8-14	3/4-16	2 1/8	6
	2	1 3/8	1 1/4-12	1-14	2 3/8	6 1/4
2 1/2	1	1	7/8-14	3/4-16	2 1/8	6 1/8
	2	1 3/4	1 1/2-12	1 1/4-12	2 5/8	6 5/8

Bore Ø	Rod No.	MM Rod Ø	Thread		Y	Add Stroke XF
			Style 8 CC	Style 4 & 9 KK		
3 1/4	1	1 3/8	1 1/4-12	1-14	2 1/2	7 1/8
	2	2	1 3/4-12	1 1/2-12	2 7/8	7 1/2
4	1	1 3/4	1 1/2-12	1 1/4-12	2 11/16	7 5/8
	2	2 1/2	2 1/4-12	1 7/8-12	3 1/16	8

Rod End Dimensions

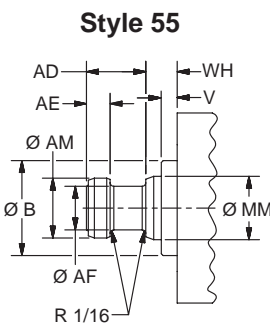
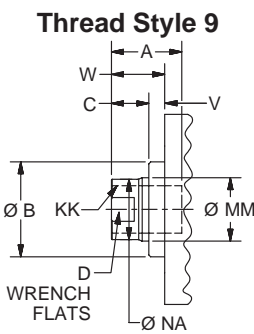
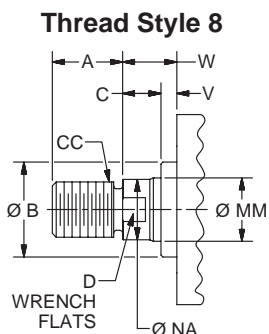
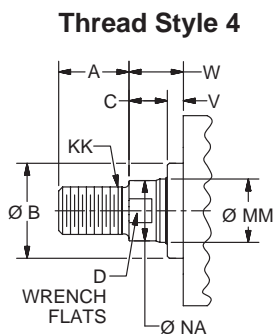

“Special” Thread Style 3
Special thread, rod eye, blank, etc. are also available. To order, specify “Style 3” and give desired dimensions for KK, A, & W. If otherwise special furnish dimensional sketch.

BE Mount – Single Rod End

1 1/2" to 4" Bore Size

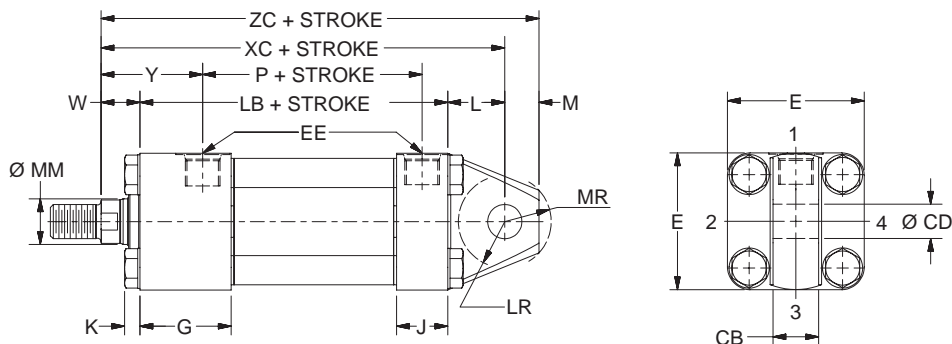
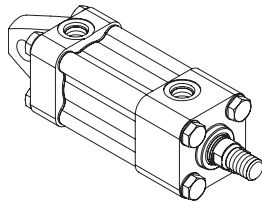

BE Mount Single Rod End – Envelope and Mounting Dimensions

Bore Ø	CB	CD +.002 -.000	E	EE		G	J	K Max	L	LR	M	MR	Add Stroke	
				NPTF	SAE								LB	P
1 1/2	3/4	0.502	2 1/2	1/2	8	1 3/4	1 1/8	7/16	3/4	9/16	1/2	11/16	5	3 1/4
2	1	0.752	3	1/2	8	2	1 1/8	1/2	1 1/4	1	3/4	1 1/16	5 1/4	3 5/16
2 1/2	1 1/4	0.752	3 1/2	1/2	8	2	1 1/8	1/2	1 1/4	15/16	3/4	1 1/16	5 3/8	3 7/16
3 1/4	1 1/2	1.002	4 1/2	3/4	10	2 3/8	1 3/8	5/8	1 1/2	1 1/4	1	1 3/8	6 1/4	3 15/16
4	2	1.376	5	3/4	12	2 1/2	1 3/8	5/8	2 1/8	1 3/4	1 3/8	1 3/4	6 5/8	4 1/4

BE Mount Single Rod End – Rod Dimensions

Bore Ø	Rod No.	MM Rod Ø	Rod Extensions and Pilot Dimensions												
			A	AD	AE	AF	AM	B +.000 -.002	C	D	NA	V	W	WH	
1 1/2	1	5/8	3/4	5/8	1/4	3/8	0.57	1.124	3/8	1/2	9/16	1/4	5/8	3/4	
	2	1	1 1/8	15/16	3/8	11/16	0.95	1.499	1/2	7/8	15/16	1/2	1	1 1/16	
2	1	1	1 1/8	15/16	3/8	11/16	0.95	1.499	1/2	7/8	15/16	1/4	3/4	13/16	
	2	1 3/8	1 5/8	1 1/16	3/8	7/8	1.32	1.999	5/8	1 1/8	1 5/16	3/8	1	1 1/16	
2 1/2	1	1	1 1/8	15/16	3/8	11/16	0.95	1.499	1/2	7/8	15/16	1/4	3/4	13/16	
	2	1 3/4	2	1 5/16	1/2	1 1/8	1.70	2.374	3/4	1 1/2	1 11/16	1/2	1 1/4	1 3/16	
3 1/4	1	1 3/8	1 5/8	1 1/16	3/8	7/8	1.32	1.999	5/8	1 1/8	1 5/16	1/4	7/8	15/16	
	2	2	2 1/4	1 11/16	5/8	1 3/8	1.95	2.624	7/8	1 11/16	1 15/16	3/8	1 1/4	1 5/16	
4	1	1 3/4	2	1 5/16	1/2	1 1/8	1.70	2.374	3/4	1 1/2	1 11/16	1/4	1	15/16	
	2	2 1/2	3	1 15/16	3/4	1 3/4	2.45	3.124	1	2 1/16	2 3/8	3/8	1 3/8	1 11/16	

Bore Ø	Rod No.	MM Rod Ø	Thread		Y	Add Stroke	
			Style 8 CC	Style 4 & 9 KK		XC	ZC
1 1/2	1	5/8	1/2-20	7/16-20	1 13/16	6 3/8	6 7/8
	2	1	7/8-14	3/4-16	2 3/16	6 3/4	7 1/4
2	1	1	7/8-14	3/4-16	2 1/8	7 1/4	8
	2	1 3/8	1 1/4-12	1-14	2 3/8	7 1/2	8 1/4
2 1/2	1	1	7/8-14	3/4-16	2 1/8	7 3/8	8 1/8
	2	1 3/4	1 1/2-12	1 1/4-12	2 5/8	7 7/8	8 5/8

Bore Ø	Rod No.	MM Rod Ø	Thread		Y	Add Stroke	
			Style 8 CC	Style 4 & 9 KK		XC	ZC
3 1/4	1	1 3/8	1 1/4-12	1-14	2 1/2	8 5/8	9 5/8
	2	2	1 3/4-12	1 1/2-12	2 7/8	9	10
4	1	1 3/4	1 1/2-12	1 1/4-12	2 11/16	9 3/4	11 1/8
	2	2 1/2	2 1/4-12	1 7/8-12	3 1/16	10 1/8	11 1/2

Rod End Dimensions

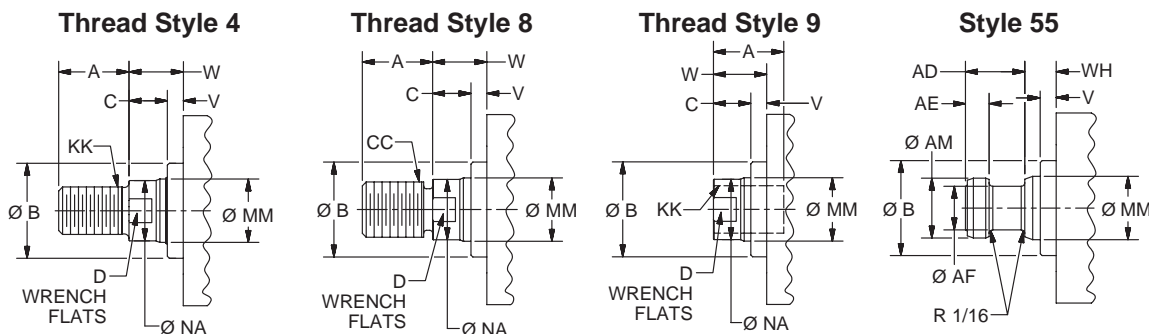

**“Special”
Thread Style 3**

Special thread, rod eye, blank, etc. are also available. To order, specify “Style 3” and give desired dimensions for KK, A, & W. If otherwise special furnish dimensional sketch.

F Mount – Single Rod End

1 1/2" to 4" Bore Size

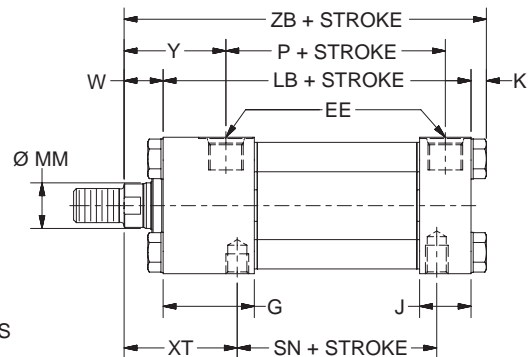
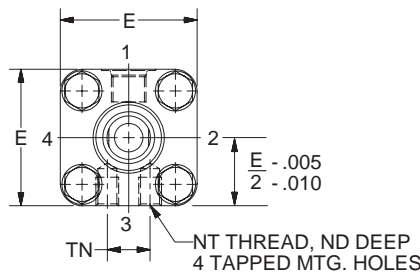
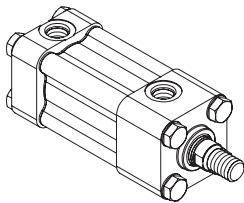

F Mount Single Rod End – Envelope and Mounting Dimensions

Bore Ø	E	EE		G	J	K Max	NT	TN	Add Stroke		
		NPTF	SAE						LB	P	SN
1 1/2	2 1/2	1/2	8	1 3/4	1 1/8	7/16	3/8-16	3/4	5	3 1/4	2 7/8
2	3	1/2	8	2	1 1/8	1/2	1/2-13	15/16	5 1/4	3 5/16	2 7/8
2 1/2	3 1/2	1/2	8	2	1 1/8	1/2	5/8-11	1 5/16	5 3/8	3 7/16	3
3 1/4	4 1/2	3/4	10	2 3/8	1 3/8	5/8	3/4-10	1 1/2	6 1/4	3 15/16	3 1/2
4	5	3/4	12	2 1/2	1 3/8	5/8	1-8	2 1/16	6 5/8	4 1/4	4

F Mount Single Rod End – Rod Dimensions

Bore Ø	Rod No.	MM Rod Ø	Rod Extensions and Pilot Dimensions											
			A	AD	AE	AF	AM	B +.000 -.002	C	D	NA	V	W	WH
1 1/2	1	5/8	3/4	5/8	1/4	3/8	0.57	1.124	3/8	1/2	9/16	1/4	5/8	3/4
	2	1	1 1/8	15/16	3/8	11/16	0.95	1.499	1/2	7/8	15/16	1/2	1	1 1/16
2	1	1	1 1/8	15/16	3/8	11/16	0.95	1.499	1/2	7/8	15/16	1/4	3/4	13/16
	2	1 3/8	1 5/8	1 1/16	3/8	7/8	1.32	1.999	5/8	1 1/8	1 5/16	3/8	1	1 1/16
2 1/2	1	1	1 1/8	15/16	3/8	11/16	0.95	1.499	1/2	7/8	15/16	1/4	3/4	13/16
	2	1 3/4	2	1 5/16	1/2	1 1/8	1.70	2.374	3/4	1 1/2	1 11/16	1/2	1 1/4	1 3/16
3 1/4	1	1 3/8	1 5/8	1 1/16	3/8	7/8	1.32	1.999	5/8	1 1/8	1 5/16	1/4	7/8	15/16
	2	2	2 1/4	1 11/16	5/8	1 3/8	1.95	2.624	7/8	1 11/16	1 15/16	3/8	1 1/4	1 5/16
4	1	1 3/4	2	1 5/16	1/2	1 1/8	1.70	2.374	3/4	1 1/2	1 11/16	1/4	1	15/16
	2	2 1/2	3	1 15/16	3/4	1 3/4	2.45	3.124	1	2 1/16	2 3/8	3/8	1 3/8	1 11/16

Bore Ø	Rod No.	MM Rod Ø	Thread		ND	XT	Y	Add Stroke ZB
			Style 8 CC	Style 4 & 9 KK				
1 1/2	1	5/8	1/2-20	7/16-20	3/8	2	1 13/16	6 1/16
	2	1	7/8-14	3/4-16	3/8	2 3/8	2 3/16	6 7/16
2	1	1	7/8-14	3/4-16	7/16	2 3/8	2 1/8	6 1/2
	2	1 3/8	1 1/4-12	1-14	7/16	2 5/8	2 3/8	6 3/4
2 1/2	1	1	7/8-14	3/4-16	1/2	2 3/8	2 1/8	6 5/8
	2	1 3/4	1 1/2-12	1 1/4-12	1/2	2 7/8	2 5/8	7 1/8

Bore Ø	Rod No.	MM Rod Ø	Thread		ND	XT	Y	Add Stroke ZB
			Style 8 CC	Style 4 & 9 KK				
3 1/4	1	1 3/8	1 1/4-12	1-14	11/16	2 3/4	2 1/2	7 3/4
	2	2	1 3/4-12	1 1/2-12	11/16	3 1/8	2 7/8	8 1/8
4	1	1 3/4	1 1/2-12	1 1/4-12	11/16	2 7/8	2 11/16	8 1/4
	2	2 1/2	2 1/4-12	1 7/8-12	11/16	3 3/4	3 1/16	8 5/8

Rod End Dimensions

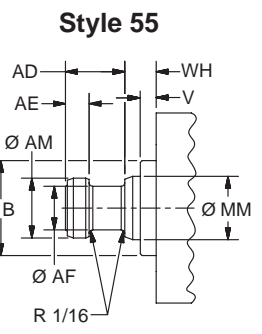
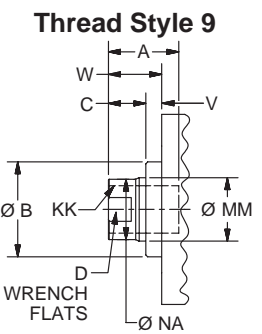
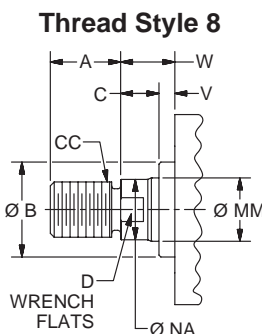
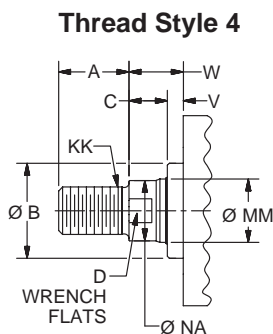

“Special” Thread Style 3
Special thread, rod eye, blank, etc. are also available. To order, specify “Style 3” and give desired dimensions for KK, A, & W. If otherwise special furnish dimensional sketch.

F Mount – Double Rod End

F Mount – Double Rod End

1 1/2" to 4" Bore Size

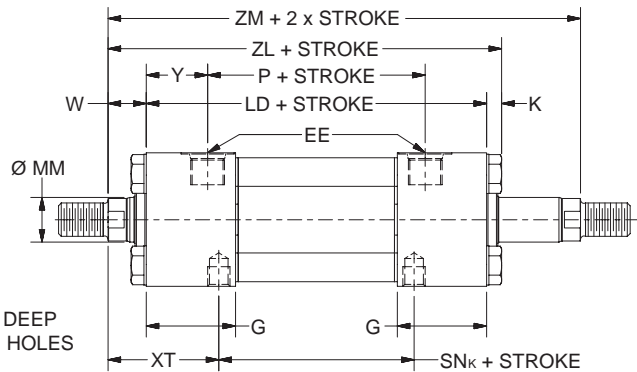
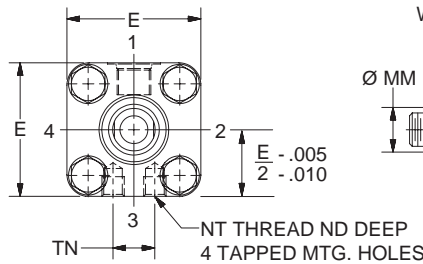
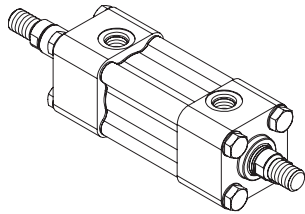

F Mount Double Rod End – Envelope and Mounting Dimensions

Bore Ø	E	EE		G	K Max	NT	TN	Add Stroke		
		NPTF	SAE					LD	P	SNk
1 1/2	2 1/2	1/2	8	1 3/4	7/16	3/8-16	3/4	5 5/8	3 1/4	2 7/8
2	3	1/2	8	2	1/2	1/2-13	15/16	6 1/8	3 3/8	2 7/8
2 1/2	3 1/2	1/2	8	2	1/2	5/8-11	1 5/16	6 1/4	3 1/2	3
3 1/4	4 1/2	3/4	10	2 3/8	5/8	3/4-10	1 1/2	7 1/4	4	3 1/2
4	5	3/4	12	2 1/2	5/8	1-8	2 1/16	7 3/4	4 3/8	4

F Mount Double Rod End – Rod Dimensions

Bore Ø	Rod No.	MM Rod Ø	Rod Extensions and Pilot Dimensions												ND	XT
			A	AD	AE	AF	AM	B +.000 -.002	C	D	NA	V	W	WH		
1 1/2	1	5/8	3/4	5/8	1/4	3/8	0.57	1.124	3/8	1/2	9/16	1/4	5/8	3/4	3/8	2
	2	1	1 1/8	15/16	3/8	11/16	0.95	1.499	1/2	7/8	15/16	1/2	1	1 1/16	3/8	2 3/8
2	1	1	1 1/8	15/16	3/8	11/16	0.95	1.499	1/2	7/8	15/16	1/4	3/4	13/16	7/16	2 3/8
	2	1 3/8	1 5/8	1 1/16	3/8	7/8	1.32	1.999	5/8	1 1/8	1 5/16	3/8	1	1 1/16	7/16	2 5/8
2 1/2	1	1	1 1/8	15/16	3/8	11/16	0.95	1.499	1/2	7/8	15/16	1/4	3/4	13/16	1/2	2 3/8
	2	1 3/4	2	1 5/16	1/2	1 1/8	1.70	2.374	3/4	1 1/2	1 11/16	1/2	1 1/4	1 3/16	1/2	2 7/8
3 1/4	1	1 3/8	1 5/8	1 1/16	3/8	7/8	1.32	1.999	5/8	1 1/8	1 5/16	1/4	7/8	15/16	11/16	2 3/4
	2	2	2 1/4	1 11/16	5/8	1 3/8	1.95	2.624	7/8	1 11/16	1 15/16	3/8	1 1/4	1 5/16	11/16	3 1/8
4	1	1 3/4	2	1 5/16	1/2	1 1/8	1.70	2.374	3/4	1 1/2	1 11/16	1/4	1	15/16	11/16	2 7/8
	2	2 1/2	3	1 15/16	3/4	1 3/4	2.45	3.124	1	2 1/16	2 3/8	3/8	1 3/8	1 11/16	11/16	3 3/4

Bore Ø	Rod No.	MM Rod Ø	Thread		Y	Add Stroke ZL	Add 2X Stroke ZM
			Style 8 CC	Style 4 & 9 KK			
1 1/2	1	5/8	1/2-20	7/16-20	1 13/16	6 11/16	6 7/8
	2	1	7/8-14	3/4-16	2 3/16	7 1/16	7 5/8
2	1	1	7/8-14	3/4-16	2 1/8	7 3/8	7 5/8
	2	1 3/8	1 1/4-12	1-14	2 3/8	7 5/8	8 1/8
2 1/2	1	1	7/8-14	3/4-16	2 1/8	7 1/2	7 3/4
	2	1 3/4	1 1/2-12	1 1/4-12	2 5/8	8	8 3/4

Bore Ø	Rod No.	MM Rod Ø	Thread		Y	Add Stroke ZL	Add 2X Stroke ZM
			Style 8 CC	Style 4 & 9 KK			
3 1/4	1	1 3/8	1 1/4-12	1-14	2 1/2	8 3/4	9
	2	2	1 3/4-12	1 1/2-12	2 7/8	9 1/8	9 3/4
4	1	1 3/4	1 1/2-12	1 1/4-12	2 11/16	9 3/8	9 3/4
	2	2 1/2	2 1/4-12	1 7/8-12	3 1/16	9 3/4	10 1/2

Rod End Dimensions

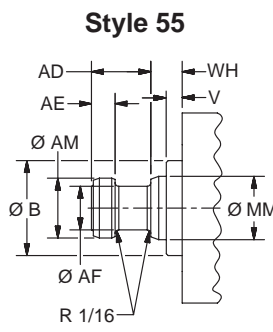
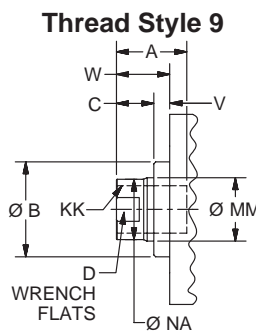
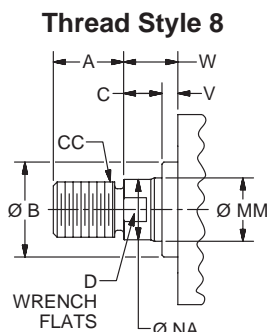
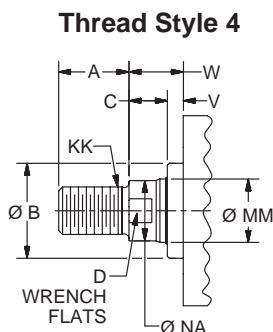

“Special” Thread Style 3

Special thread, extension, rod eye, blank, etc. are also available. To order, specify “Style 3” and give desired dimensions for KK, A, & W. If otherwise special furnish dimensional sketch.

D Mount – Single Rod End

D Mount – Single Rod End

1 1/2" to 4" Bore Size

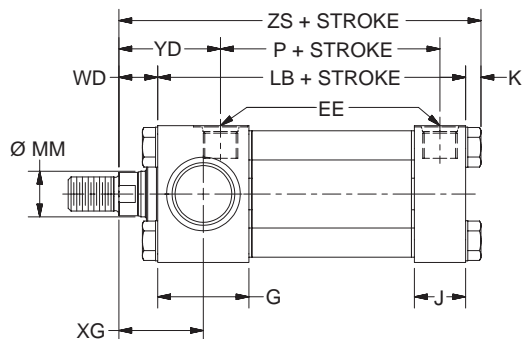
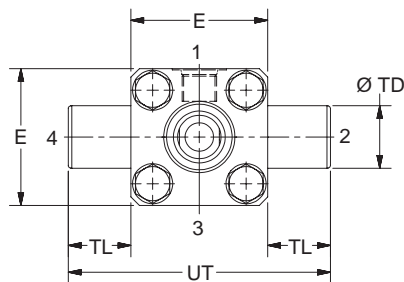
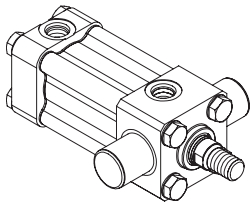

D Mount Single Rod End – Envelope and Mounting Dimensions

Bore Ø	E	EE		G	J	K Max	TD +.000 -.001	TL	UT	Add Stroke	
		NPTF	SAE							LB	P
1 1/2	2 1/2	1/2	8	1 3/4	1 1/8	7/16	1.000	1	4 1/2	5	3 1/4
2	3	1/2	8	2	1 1/8	1/2	1.375	1 3/8	5 3/4	5 1/4	3 5/16
2 1/2	3 1/2	1/2	8	2	1 1/8	1/2	1.375	1 3/8	6 1/4	5 3/8	3 7/16
3 1/4	4 1/2	3/4	10	2 3/8	1 3/8	5/8	1.750	1 3/4	8	6 1/4	3 15/16
4	5	3/4	12	2 1/2	1 3/8	5/8	1.750	1 3/4	8 1/2	6 5/8	4 1/4

D Mount Single Rod End – Rod Dimensions

Bore Ø	Rod No.	MM Rod Ø	Rod Extensions and Pilot Dimensions											
			A	AD	AE	AF	AM	B +.000 -.002	C	D	NA	V	WD	WJ
1 1/2	1	5/8	3/4	5/8	1/4	3/8	0.57	1.124	3/8	1/2	9/16	1/4	1	1 1/8
	2	1	1 1/8	15/16	3/8	11/16	0.95	1.499	1/2	7/8	15/16	1/2	1 3/8	1 7/16
2	1	1	1 1/8	15/16	3/8	11/16	0.95	1.499	1/2	7/8	15/16	1/4	1 1/4	1 5/16
	2	1 3/8	1 5/8	1 1/16	3/8	7/8	1.32	1.999	5/8	1 1/8	1 5/16	3/8	1 1/2	1 9/16
2 1/2	1	1	1 1/8	15/16	3/8	11/16	0.95	1.499	1/2	7/8	15/16	1/4	1 1/4	1 5/16
	2	1 3/4	2	1 5/16	1/2	1 1/8	1.70	2.374	3/4	1 1/2	1 11/16	1/2	1 3/4	1 11/16
3 1/4	1	1 3/8	1 5/8	1 1/16	3/8	7/8	1.32	1.999	5/8	1 1/8	1 5/16	1/4	1 7/16	1 1/2
	2	2	2 1/4	1 11/16	5/8	1 3/8	1.95	2.624	7/8	1 11/16	1 15/16	3/8	1 13/16	1 7/8
4	1	1 3/4	2	1 5/16	1/2	1 1/8	1.70	2.374	3/4	1 1/2	1 11/16	1/4	1 5/8	1 9/16
	2	2 1/2	3	1 15/16	3/4	1 3/4	2.45	3.124	1	2 1/16	2 3/8	3/8	2	2 5/16

Bore Ø	Rod No.	MM Rod Ø	Thread		XG	YD	Add Stroke ZS
			Style 8 CC	Style 4 & 9 KK			
1 1/2	1	5/8	1/2-20	7/16-20	1 7/8	2 3/16	6 7/16
	2	1	7/8-14	3/4-16	2 1/4	2 9/16	6 13/16
2	1	1	7/8-14	3/4-16	2 1/4	2 5/8	7
	2	1 3/8	1 1/4-12	1-14	2 1/2	2 7/8	7 1/4
2 1/2	1	1	7/8-14	3/4-16	2 1/4	2 5/8	7 1/8
	2	1 3/4	1 1/2-12	1 1/4-12	2 3/4	3 1/8	7 5/8

Bore Ø	Rod No.	MM Rod Ø	Thread		XG	YD	Add Stroke ZS
			Style 8 CC	Style 4 & 9 KK			
3 1/4	1	1 3/8	1 1/4-12	1-14	2 5/8	3 1/16	8 5/16
	2	2	1 3/4-12	1 1/2-12	3	3 7/16	8 11/16
4	1	1 3/4	1 1/2-12	1 1/4-12	2 7/8	3 5/16	8 7/8
	2	2 1/2	2 1/4-12	1 7/8-12	3 1/4	3 11/16	9 1/4

Rod End Dimensions

Thread Style 4

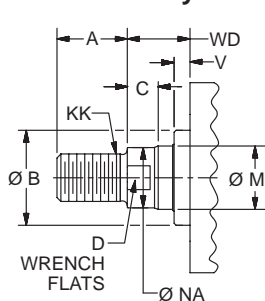

Thread Style 8

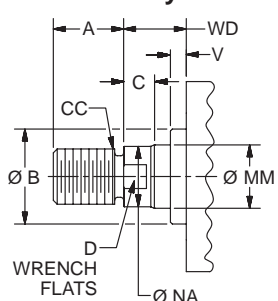

Thread Style 9

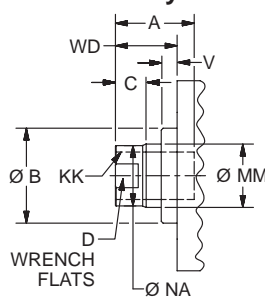

Style 55

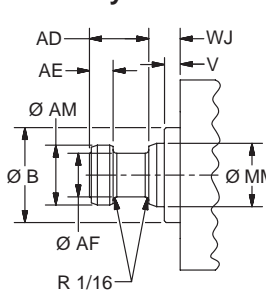

“Special” Thread Style 3

Special thread, rod eye, blank, etc. are also available. To order, specify “Style 3” and give desired dimensions for KK, A, & WD. If otherwise special furnish dimensional sketch.

D Mount – Double Rod End

D Mount – Double Rod End

1 1/2" to 4" Bore Size

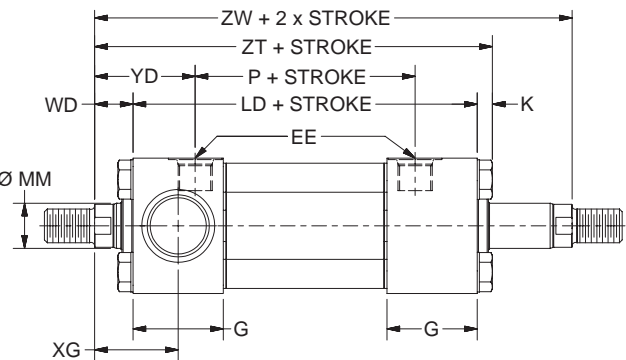
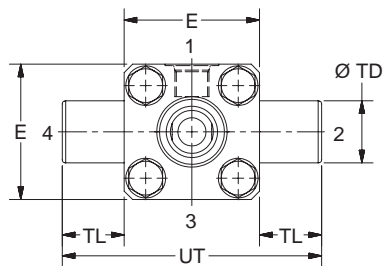
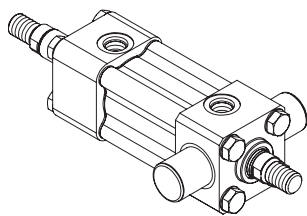

D Mount Double Rod End – Envelope and Mounting Dimensions

Bore Ø	E	EE		G	Max K	TD +.000 -.001	TL	UT	Add Stroke	
		NPTF	SAE						LD	P
1 1/2	2 1/2	1/2	8	1 3/4	7/16	1.000	1	4 1/2	5 5/8	3 1/4
2	3	1/2	8	2	1/2	1.375	1 3/8	5 3/4	6 1/8	3 3/8
2 1/2	3 1/2	1/2	8	2	1/2	1.375	1 3/8	6 1/4	6 1/4	3 1/2
3 1/4	4 1/2	3/4	10	2 3/8	5/8	1.750	1 3/4	8	7 1/4	4
4	5	3/4	12	2 1/2	5/8	1.750	1 3/4	8 1/2	7 3/4	4 3/8

D Mount Double Rod End – Rod Dimensions

Bore Ø	Rod No.	MM Rod Ø	Rod Extensions and Pilot Dimensions												XG	YD
			A	AD	AE	AF	AM	B +.000 -.002	C	D	NA	V	WD	WJ		
1 1/2	1	5/8	3/4	5/8	1/4	3/8	0.57	1.124	3/8	1/2	9/16	1/4	1	1 1/8	1 7/8	2 3/16
	2	1	1 1/8	15/16	3/8	11/16	0.95	1.499	1/2	7/8	15/16	1/2	1 3/8	1 7/16	2 1/4	2 9/16
2	1	1	1 1/8	15/16	3/8	11/16	0.95	1.499	1/2	7/8	15/16	1/4	1 1/4	1 5/16	2 1/4	2 5/8
	2	1 3/8	1 5/8	1 1/16	3/8	7/8	1.32	1.999	5/8	1 1/8	1 5/16	3/8	1 1/2	1 9/16	2 1/2	2 7/8
2 1/2	1	1	1 1/8	15/16	3/8	11/16	0.95	1.499	1/2	7/8	15/16	1/4	1 1/4	1 5/16	2 1/4	2 5/8
	2	1 3/4	2	1 5/16	1/2	1 1/8	1.70	2.374	3/4	1 1/2	1 11/16	1/2	1 3/4	1 11/16	2 3/4	3 1/8
3 1/4	1	1 3/8	1 5/8	1 1/16	3/8	7/8	1.32	1.999	5/8	1 1/8	1 5/16	1/4	1 7/16	1 1/2	2 5/8	3 1/16
	2	2	2 1/4	1 11/16	5/8	1 3/8	1.95	2.624	7/8	1 11/16	1 15/16	3/8	1 13/16	1 7/8	3	3 7/16
4	1	1 3/4	2	1 5/16	1/2	1 1/8	1.70	2.374	3/4	1 1/2	1 11/16	1/4	1 5/8	1 9/16	2 7/8	3 5/16
	2	2 1/2	3	1 15/16	3/4	1 3/4	2.45	3.124	1	2 1/16	2 3/8	3/8	2	2 5/16	3 1/4	3 11/16

Bore Ø	Rod No.	MM Rod Ø	Thread		Add Stroke ZT	Add 2X Stroke ZW
			Style 8 CC	Style 4 & 9 KK		
1 1/2	1	5/8	1/2-20	7/16-20	7 1/16	7 1/4
	2	1	7/8-14	3/4-16	7 7/16	8
2	1	1	7/8-14	3/4-16	7 7/8	8 1/8
	2	1 3/8	1 1/4-12	1-14	8 1/8	8 5/8
2 1/2	1	1	7/8-14	3/4-16	8	8 1/4
	2	1 3/4	1 1/2-12	1 1/4-12	8 1/2	9 1/4

Bore Ø	Rod No.	MM Rod Ø	Thread		Add Stroke ZT	Add 2X Stroke ZW
			Style 8 CC	Style 4 & 9 KK		
3 1/4	1	1 3/8	1 1/4-12	1-14	9 5/16	9 9/16
	2	2	1 3/4-12	1 1/2-12	9 11/16	10 5/16
4	1	1 3/4	1 1/2-12	1 1/4-12	10	10 3/8
	2	2 1/2	2 1/4-12	1 7/8-12	10 3/8	11 1/8

Rod End Dimensions

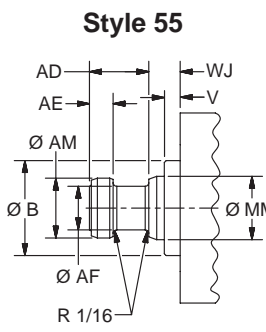
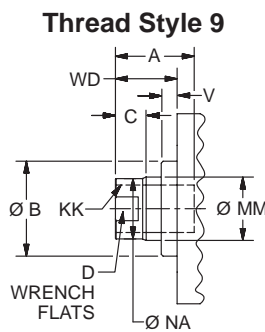
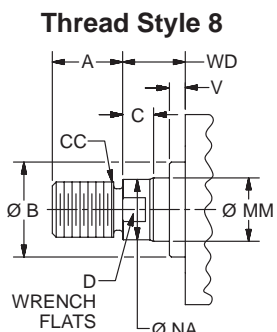
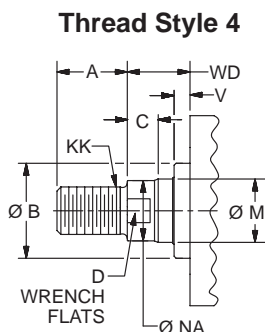

“Special” Thread Style 3

Special thread, extension, rod eye, blank, etc. are also available. To order, specify “Style 3” and give desired dimensions for KK, A, & WD. If otherwise special furnish dimensional sketch.

Accessories

Cylinder Accessories

Type 316 Stainless Steel mounting accessories are offered to provide you a complete corrosion resistant cylinder mounting package. A Clevis Bracket and (17-4 SS) Pivot Pin are available for Mounting Style BE. Select the Clevis Bracket and Pin in the row to the right of the bore size cylinder required.

Rod End Accessories

Accessories offered for the rod end of the cylinder include Rod Clevis, Knuckle, Eye Bracket, Clevis Bracket and (17-4 SS) Pivot Pin. To select the proper part number for any desired accessory, refer to the table below or on the opposite page and look in the row to the right of the rod thread in the first column. For economical accessory selection, it is recommended that rod end style 4 be specified on your cylinder order.

Accessory Load Capacity

The various accessories have been load rated for your convenience. The load capacity in lbs. is the recommended maximum load for that accessory based on a 4:1 design factor in tension. (Pivot pin is rated in shear). Before specifying, compare the actual load or the tension (pull) force at maximum operating pressure of the cylinder with the load capacity of the accessory you plan to use. If the load or pull force of the cylinder exceeds the accessory capacity, consult the factory.

All Accessories Include Electropolishing

Rod End Accessories

Thread Size	Rod Clevis		Eye Bracket		Pivot Pin	
	Part Number	Load Capacity (Lbs.)	Part Number	Load Capacity (Lbs.)	Part Number	Load Capacity (Lbs.)
7/16-20	0938480000	2125	0938680000	2050	0938820000	8000
1/2-20	0938490000	2450	0938680000	2050	0938820000	8000
3/4-16	0938500000	5600	0938690000	5800	0938830000	17900
7/8-14	0938510000	9400	0938700000	12200	0938840000	31900
1-14	0938520000	9750	0938700000	12200	0938840000	31900
1 1/4-12	0938530000	22300	0938710000	12720	0938850000	60500
1 1/2-12	0938540000	30400	0938720000	32900	0938860000	98000
1 3/4-12	0938550000	43700	0938730000	46600	0938870000	127700
1 7/8-12	0938560000	43700	0938730000	46600	0938870000	127700
2 1/4-12	0938570000	65400	0938740000	62800	0938880000	199600

Rod End Accessories

Thread Size	Knuckle		Clevis Bracket		Pivot Pin	
	Part Number	Load Capacity (Lbs.)	Part Number	Load Capacity (Lbs.)	Part Number	Load Capacity (Lbs.)
7/16-20	0938580000	2700	0938750000	3650	0938820000	8000
1/2-20	0938590000	3100	0938750000	3650	0938820000	8000
3/4-16	0938600000	7200	0938760000	7000	0938830000	17900
7/8-14	0938610000	7800	0938770000	9600	0938840000	31900
1-14	0938620000	13000	0938770000	9600	0938840000	31900
1 1/4-12	0938630000	20000	0938780000	20120	0938850000	60500
1 1/2-12	0938640000	30000	0938790000	20300	0938860000	98000
1 3/4-12	0938650000	35500	0938800000	19700	0938870000	127700
1 7/8-12	0938660000	50000	0938800000	19700	0938870000	127700
2 1/4-12	0938670000	65000	0938810000	20900	0938880000	199600

Cylinder Accessories

Bore Ø	Clevis Bracket		Pivot Pin	
	Part Number	Load Capacity (Lbs.)	Part Number	Load Capacity (Lbs.)
1 1/2	0938750000	3650	0938820000	8000
2, 2 1/2	0938760000	7000	0938830000	17900
3 1/4	0938770000	9600	0938840000	31900
4	0938780000	20120	0938850000	60500

Rod Clevis Dimensions

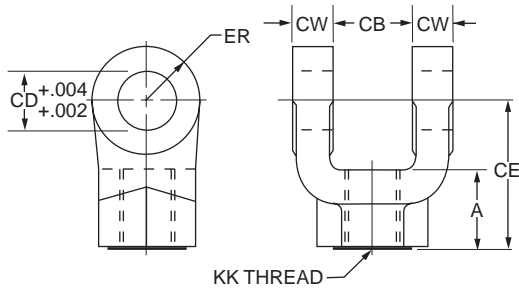

Part Number	A	CB	CD	CE	CW	ER	KK
0938480000	3/4	3/4	1/2	1 1/2	1/2	1/2	7/16-20
0938490000	3/4	3/4	1/2	1 1/2	1/2	1/2	1/2-20
0938500000	1 1/8	1 1/4	3/4	2 3/8	5/8	3/4	3/4-16
0938510000	1 5/8	1 1/2	1	3 1/8	3/4	1	7/8-14
0938520000	1 5/8	1 1/2	1	3 1/8	3/4	1	1-14
0938530000	1 7/8	2	1 3/8	4 1/8	1	1 3/8	1 1/4-12
0938540000	2 1/4	2 1/2	1 3/4	4 1/2	1 1/4	1 3/4	1 1/2-12
0938550000	3	2 1/2	2	5 1/2	1 1/4	2	1 3/4-12
0938560000	3	2 1/2	2	5 1/2	1 1/4	2	1 7/8-12
0938570000	3 1/2	3	2 1/2	6 1/2	1 1/2	2 1/2	2 1/4-12

Pivot Pin Dimensions

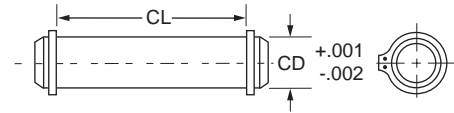

Part Number	CD	CL
0938820000	1/2	1 7/8
0938830000	3/4	2 5/8
0938840000	1	3 1/8
0938850000	1 3/8	4 1/8
0938860000	1 3/4	5 3/16
0938870000	2	5 3/16
0938880000	2 1/2	6 3/16

1. Pivot Pins are furnished with (2) retainers rings.
2. Pivot Pins must be ordered as a separate item if to be used with Rod Clevises or Clevis Brackets.

Eye Bracket Dimensions

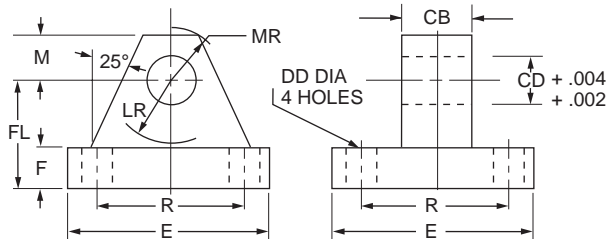

Part Number	CB	CD	DD	E	F	FL	LR	M	MR	R
0968680000	3/4	1/2	13/32	2 1/2	3/8	1 1/8	3/4	1/2	9/16	1.63
0938690000	1 1/4	3/4	17/32	3 1/2	5/8	1 7/8	1 1/4	3/4	7/8	2.55
0938700000	1 1/2	1	21/32	4 1/2	7/8	2 3/8	1 1/2	1	1 1/4	3.25
0938710000	2	1 3/8	21/32	5	7/8	3	2 1/8	1 3/8	1 5/8	3.82
0938720000	2 1/2	1 3/4	29/32	6 1/2	1 1/8	3 3/8	2 1/4	1 3/4	2 1/8	4.95
0938730000	2 1/2	2	1 1/16	7 1/2	1 1/2	4	2 1/2	2	2 7/16	5.73
0938740000	3	2 1/2	1 3/16	8 1/2	1 3/4	4 3/4	3	2 1/2	3	6.58

Knuckle Dimensions

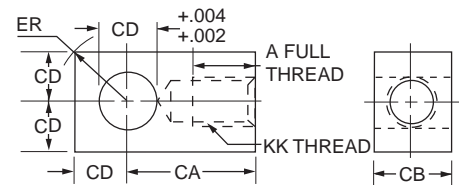

Part Number	A	CA	CB
0938580000	3/4	1 1/2	3/4
0938590000	3/4	1 1/2	3/4
0938600000	1 1/8	2 1/16	1 1/4
0938610000	1 1/8	2 3/8	1 1/2
0938620000	1 5/8	2 13/16	1 1/2
0938630000	2	3 7/16	2
0938640000	2 1/4	4	2 1/2
0938650000	2 1/4	4 3/8	2 1/2
0938660000	3	5	2 1/2
0938670000	3 1/2	5 13/16	3

Clevis Bracket Dimensions

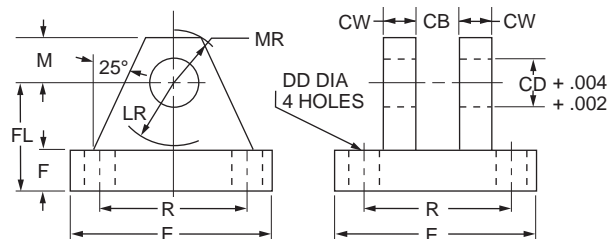

Part Number	CB	CD	CW	DD	E	F	FL	LR	M	MR	R
0938750000	3/4	1/2	1/2	13/32	3 1/2	1/2	1 1/2	3/4	1/2	5/8	2.55
0938760000	1 1/4	3/4	5/8	17/32	5	5/8	1 7/8	1 3/16	3/4	29/32	3.82
0938770000	1 1/2	1	3/4	21/32	6 1/2	3/4	2 1/4	1 1/2	1	1 1/4	4.95
0938780000	2	1 3/8	1	21/32	7 1/2	7/8	3	2	1 3/8	1 21/32	5.73
0938790000	2 1/2	1 3/4	1 1/4	29/32	9 1/2	7/8	3 5/8	2 3/4	1 3/4	2 7/32	7.50
0938800000	2 1/2	2	1 1/2	1 1/16	12 3/4	1	4 1/4	3 3/16	2 1/4	2 25/32	9.40
0938810000	3	2 1/2	1 1/2	1 3/16	12 3/4	1	4 1/2	3 1/2	2 1/2	3 1/8	9.40

Part Number	CD	ER	KK
0938580000	1/2	23/32	7/16-20
0938590000	1/2	23/32	1/2-20
0938600000	3/4	1 1/16	3/4-16
0938610000	1	1 7/16	7/8-14
0938620000	1	1 7/16	1-14
0938630000	1 3/8	1 31/32	1 1/4-12
0938640000	1 3/4	2 1/2	1 1/2-12
0938650000	2	2 27/32	1 3/4-12
0938660000	2	2 27/32	1 7/8-12
0938670000	2 1/2	3 9/16	2 1/4-12

Stop Tubing

Stop tube is recommended to lengthen the distance between the gland and piston to reduce bearing loads when the cylinder is fully extended. This is especially true of horizontally mounted and long stroke cylinders. Long stroke cylinders achieve additional stability through the use of a stop tube.

Drawing A

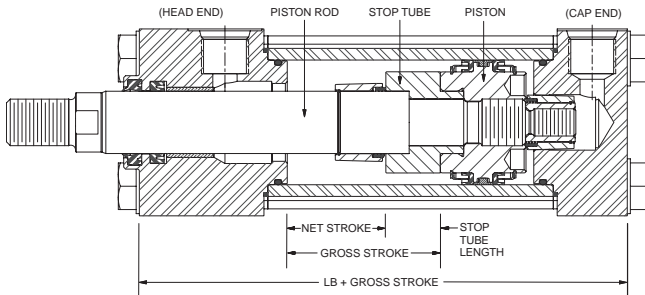

When specifying cylinders with long stroke and stop tube, be sure to call out the net stroke and the length of the stop tube. Machine design can be continued without delay by laying in a cylinder equivalent in length to the NET STROKE PLUS STOP TUBE LENGTH, which is referred to as GROSS STROKE.

Refer to piston rod/stroke selection chart to determine stop tube length.

Drawing B

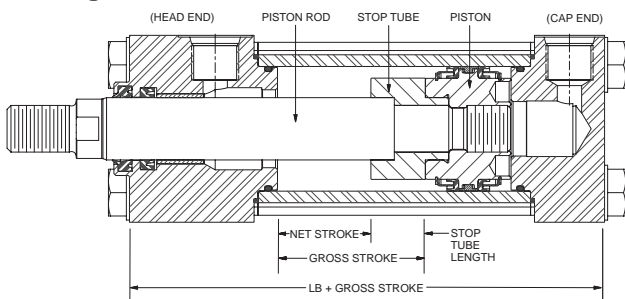

This design is supplied on all non cushion cylinders.

Mounting Classes

Standard mountings for fluid power cylinders fall into three basic groups. The groups can be summarized as follows:

- Group 1 – Straight Line Force Transfer with fixed mounts which absorb force on cylinder centerline.
- Group 2 – Pivot Force Transfer. Pivot mountings permit a cylinder to change its alignment in one plane.
- Group 3 – Straight Line Force Transfer with fixed mounts which do not absorb force on cylinder centerline.

Because a cylinder's mounting directly affects the maximum pressure at which the cylinder can be used, the chart below should be helpful in selection of the proper mounting combination for your application. Stroke length, piston rod connection to load, extra piston rod length over standard, etc., should be considered for thrust loads. Alloy steel mounting bolts are recommended for all mounting styles, and thrust keys are recommended for Group 3.

<p>Group 1 FIXED MOUNTS which absorb force on cylinder centerline.</p>	
<p>For Thrust Loads For Tension Loads</p>	<p>Mtg. Styles HH, TC Mtg. Styles JJ, TB</p>
<p>Group 2 PIVOT MOUNTS which absorb force on cylinder centerline.</p>	
<p>Heavy-Duty Service For Thrust Loads For Tension Loads</p>	<p>Mtg. Style D Mtg. Styles BE, D</p>
<p>Group 3 FIXED MOUNTS which do not absorb force on the centerline.</p>	
<p>For Thrust Loads For Tension Loads</p>	<p>Mtg. Style F Mtg. Style F</p>

Piston Rod — Stroke Selection Chart

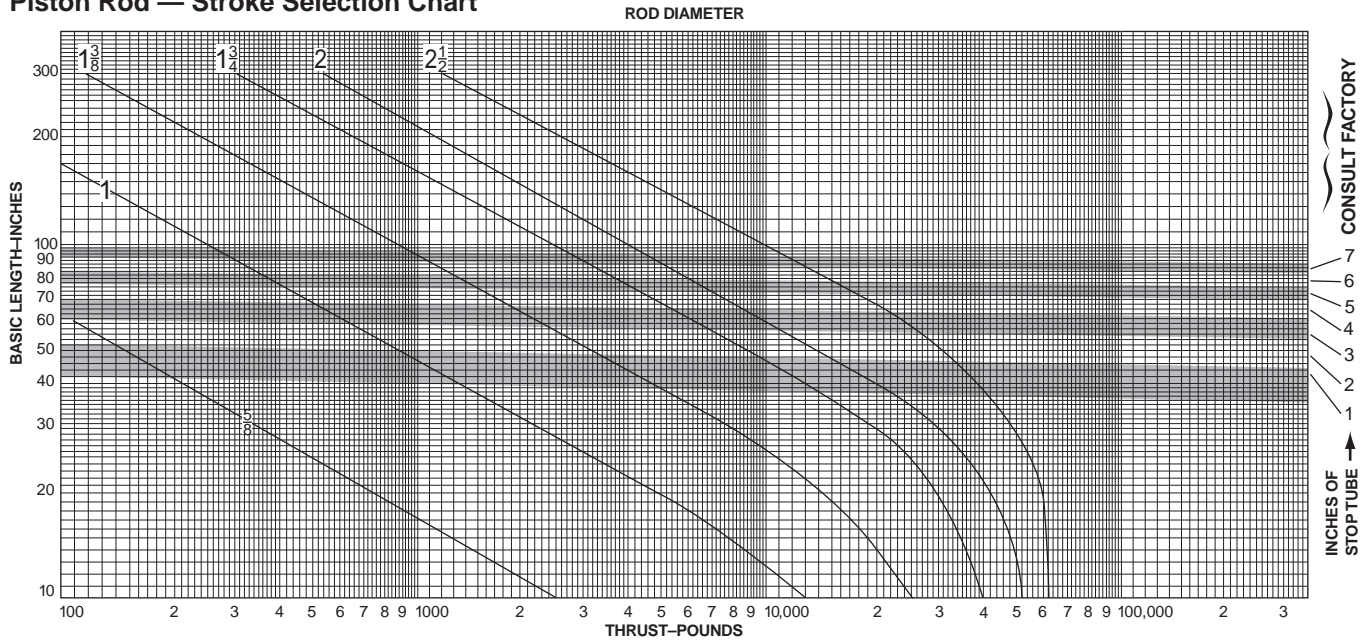

How to Use the Chart

The selection of a piston rod for thrust (push) conditions requires the following steps:

1. Determine the type of cylinder mounting style and rod end connection to be used. Then consult the chart below and find the "stroke factor" that corresponds to the conditions used.
2. Using this stroke factor, determine the "basic length" from the equation:

$$\text{Basic Length} = \frac{\text{Actual Stroke}}{\text{Stroke Factor}}$$

The graph is prepared for standard rod extensions beyond the face of the head. For rod extensions greater than standard, add the increase to the stroke in arriving at the "basic length."
3. Find the load imposed for the thrust application by multiplying the full bore area of the cylinder by the system pressure.
4. Enter the graph along the values of "basic length" and "thrust" as found above and note the point of intersection:
 - A) The correct piston rod size is read from the diagonally curved line labeled "Rod Diameter" next above the point of intersection.
 - B) The required length of stop tube is read from the right of the graph by following the shaded band in which the point of intersection lies.

C) If required length of stop tube is in the region labeled "consult factory," submit the following information for an individual analysis:

- 1) Cylinder mounting style.
- 2) Rod end connection and method of guiding load.
- 3) Bore, required stroke, length of rod extension (Dim. "A" and "W") if greater than standard, and series of cylinder used.
- 4) Mounting position of cylinder. (Note: If at an angle or vertical, specify direction of piston rod.)
- 5) Operating pressure of cylinder if limited to less than standard pressure for cylinder selected.

Warning ⚠

Piston rods are not normally designed to absorb bending moments or loads which are perpendicular to the axis of piston rod motion. These additional loads can cause the piston rod end to fail. If these types of additional loads are expected to be imposed on the piston rods, their magnitude should be made known to our Engineering Department so they may be properly addressed. Additionally, cylinder users should always make sure that the piston rod is securely attached to the machine member.

Recommended Mounting Styles for Maximum Stroke and Thrust Loads	Rod End Connection	Case	Stroke Factor
Groups 1 or 3 Long stroke cylinders for thrust loads should be firmly fixed at one end and aligned to take the principal force. Additional mounting should be specified at the opposite end, which should be used for alignment and support. An intermediate support may also be desirable for long stroke cylinders mounted horizontally. Machine mounting pads can be adjustable for support mountings to achieve proper alignment.	Fixed and Rigidly Guided	I	.50
	Pivoted and Rigidly Guided	II	.70
	Supported but not Rigidly Guided	III	2.00
Group 2 Style D — Trunnion on Head	Pivoted and Rigidly Guided	IV	1.00
Style BE — Eye on Cap	Pivoted and Rigidly Guided	V	2.00

Parts List

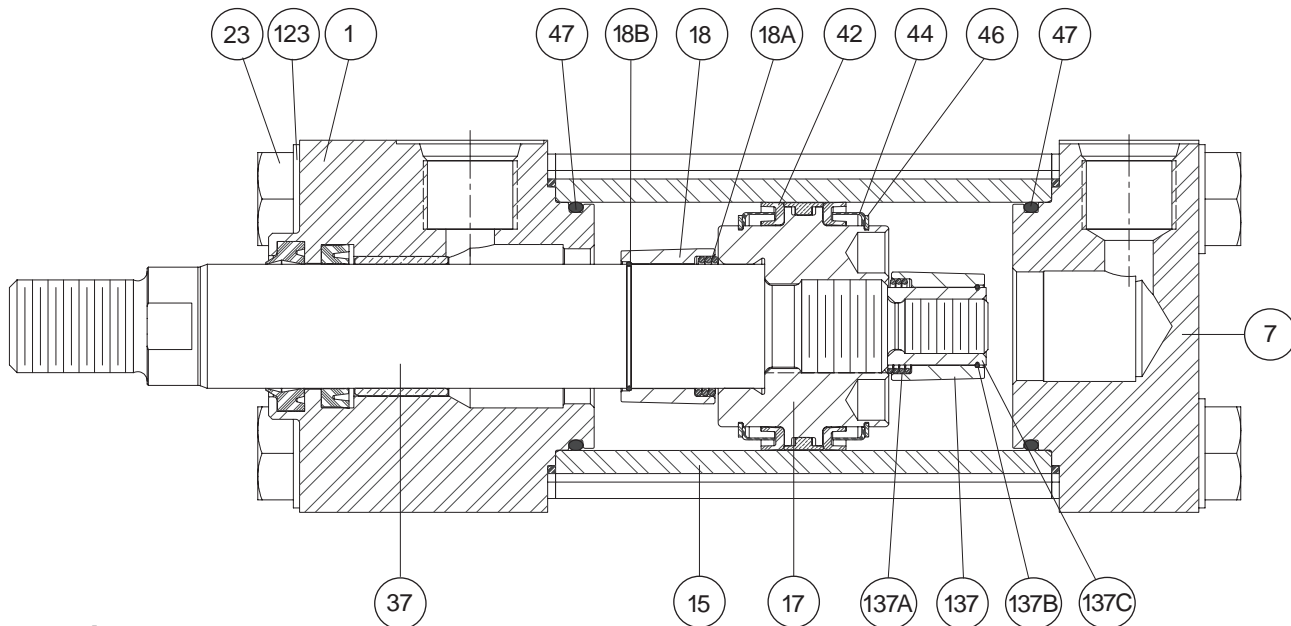

Parts List

Symbol	Description
1	Head
7	Cap
15	Cylinder Body
17	Piston, lipseal type
18	Cushion sleeve, head end cushion
18A	Cushion check spring, head end cushion
18B	Cushion retaining wire, head end cushion
23	Bolt, head and cap to body
37	Piston rod, single rod type
42	Lipseal, piston
44	Anti-roll ring, piston lipseal
46	Retaining ring, piston lipseal
47	O-ring, cylinder body to head and cap seal
118	Piston, Hi-Load type*
119	Outer ring
120	Inner ring
121	Wear ring
123	Washer
137	Cushion sleeve, cap end cushion
137A	Cushion check spring, cap end cushion
137B	Cushion retaining wire, cap end cushion
137C	Cushion support, cap end cushion

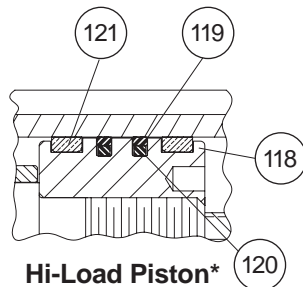

Piston and Rod Assemblies

Factory assembled piston and rod assemblies (that include seals for the piston type specified) are recommended.

*Hi-Load Piston design available only in 1 1/2", 2" and 2 1/2" bores with oversize rod.

Thrust Key Mounting

In addition to mounting bolts, Style F cylinders should be keyed to the mounting surface with a thrust key.

An optional groove can be supplied in the head for installing a thrust key.

Bore	+0.01 -0.000	PA	TA
	FA		
1 1/2	0.312	5/32	5/8
2	0.375	3/16	3/4
2 1/2	0.375	3/16	3/4
3 1/4	0.500	1/4	7/8
4	0.500	1/4	7/8

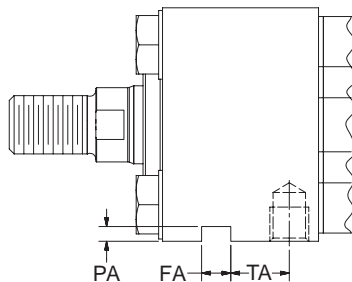

Parts Identification

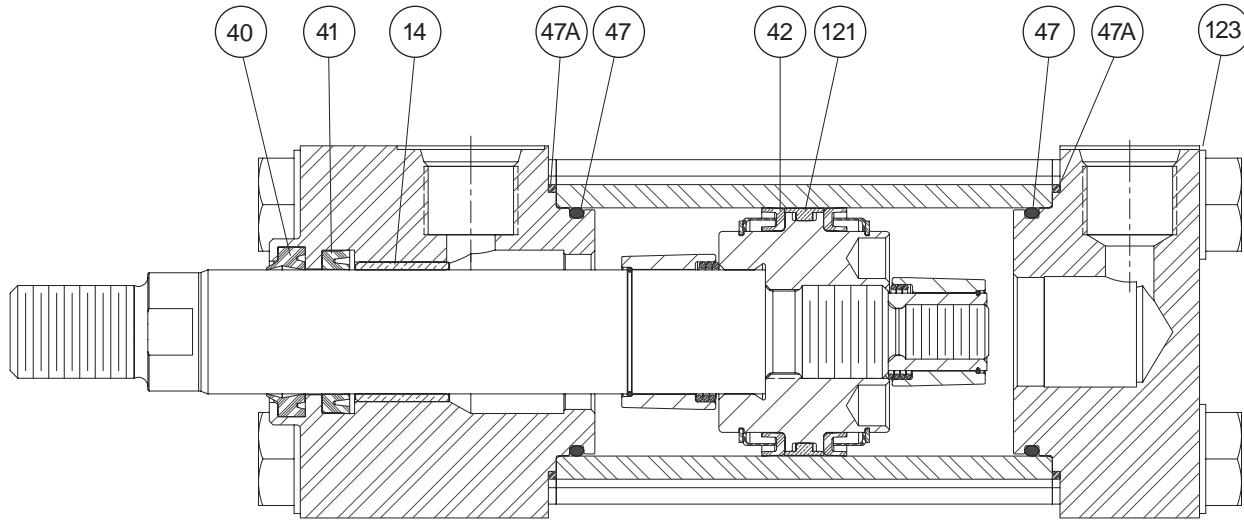

Parts List

Symbol	Description	Symbol	Description
14	Rod bearing	47A	Gasket, cylinder body to head and cap seal
40	Rod wiper	119	Outer Ring
41	Rod Seal	120	Inner Ring
42	Lipseal, piston	121	Wear ring
47	O-ring, cylinder body to head and cap seal	123	Washer

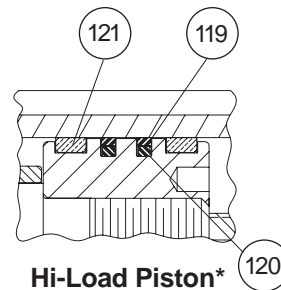

Hi-Load Piston*

*Hi-Load Piston design available only in 1 1/2", 2" and 2 1/2" bores with oversize rod.

Seal Kits

See Model Code and Standard Specifications page for compatibility.

Piston Seal Kits

Bore Ø	Rod Ø	Class 1		Class 5	
		Piston Lipseal Kits (contains: 2 Each Sym. # 42, 47 & 47A)	Hi-Load Piston Seal Kits (contains: 2 Each Sym. # 119, 120, 121, 47 & 47A)	Piston Lipseal Kits (contains: 2 Each Sym. # 42, 47 & 47A)	Hi-Load Piston Seal Kits (contains: 2 Each Sym. # 119, 120, 121, 47 & 47A)
1 1/2	5/8	PK15SHG001	N/A	PK15SHG005	N/A
	1	N/A	PK15SHGK01	N/A	PK15SHGK05
2	1	PK20SHG001	N/A	PK20SHG005	N/A
	1 3/8	N/A	PK20SHGK01	N/A	PK20SHGK05
2 1/2	1	PK25SHG001	N/A	PK25SHG005	N/A
	1 3/4	N/A	PK25SHGK01	N/A	PK25SHGK05
3 1/4	All	PK32SHG001	N/A	PK32SHG005	N/A
4	All	PK40SHG001	N/A	PK40SHG005	N/A

Note: Lipseal piston design is not available in 1 1/2", 2", and 2 1/2" bores with oversize rod. Use Hi-Load piston seal kit to service these bore and rod combinations.

Rod Bearing and Seal Kits

Bore Ø	Rod Ø	Class 1	Class 5
		Rod Bearing & Seal Kits (contains: 1 Each Sym. # 14, 40, 41, 47 & 47A)	Rod Bearing & Seal Kits (contains: 1 Each Sym. # 14, 40, 41, 47 & 47A)
1 1/2	5/8	RGSHG15061	RGSHG15065
	1	RGSHG15101	RGSHG15105
2	1	RGSHG20101	RGSHG20105
	1 3/8	RGSHG20131	RGSHG20135
2 1/2	1	RGSHG25101	RGSHG25105
	1 3/4	RGSHG25171	RGSHG25175
3 1/4	1 3/8	RGSHG32131	RGSHG32135
	2	RGSHG32201	RGSHG32205
4	1 3/4	RGSHG40171	RGSHG40175
	2 1/2	RGSHG40251	RGSHG40255

Stat-O-Seal™ Washer Kit
for Series SHG†

Bore Ø	Stat-O-Seal Washer Kit (contains: 8 Each Sym. # 123)	Head & Cap Bolt Torque†† (ft. lbs.)
1 1/2	WK15SHG001	18 - 19
2, 2 1/2	WK25SHG001	46 - 49
3 1/4	WK40SHG001	120 - 124
4	WK40SHG001	131 - 135

† Stat-O-Seal washers must be replaced when reassembling a Series SHG cylinder.

†† Anti-seize lubricant required on bolt thread.

H-1 rated anti-seize lubricant must be used for Series SHG.

Safety Guide for Selecting and Using Hydraulic, Pneumatic Cylinders and Their Accessories

WARNING: ⚠ **FAILURE OF THE CYLINDER, ITS PARTS, ITS MOUNTING, ITS CONNECTIONS TO OTHER OBJECTS, OR ITS CONTROLS CAN RESULT IN:**

- Unanticipated or uncontrolled movement of the cylinder or objects connected to it.
- Falling of the cylinder or objects held up by it.
- Fluid escaping from the cylinder, potentially at high velocity.

THESE EVENTS COULD CAUSE DEATH OR PERSONAL INJURY BY, FOR EXAMPLE, PERSONS FALLING FROM HIGH LOCATIONS, BEING CRUSHED OR STRUCK BY HEAVY OR FAST MOVING OBJECTS, BEING PUSHED INTO DANGEROUS EQUIPMENT OR SITUATIONS, OR SLIPPING ON ESCAPED FLUID.

Before selecting or using Atlas (The Company) cylinders or related accessories, it is important that you read, understand and follow the following safety information. Training is advised before selecting and using The Company's products.

1.0 General Instructions

1.1 Scope – This safety guide provides instructions for selecting and using (including assembling, installing, and maintaining) cylinder products. This safety guide is a supplement to and is to be used with the specific Company publications for the specific cylinder products that are being considered for use.

1.2 Fail Safe – Cylinder products can and do fail without warning for many reasons. All systems and equipment should be designed in a fail-safe mode so that if the failure of a cylinder product occurs people and property won't be endangered.

1.3 Distribution – Provide a free copy of this safety guide to each person responsible for selecting or using cylinder products. Do not select or use The Company's cylinders without thoroughly reading and understanding this safety guide as well as the specific Company publications for the products considered or selected.

1.4 User Responsibility – Due to very wide variety of cylinder applications and cylinder operating conditions, The Company does not warrant that any particular cylinder is suitable for any specific application. This safety guide does not analyze all technical parameters that must be considered in selecting a product. The hydraulic and pneumatic cylinders outlined in this catalog are designed to The Company's design guidelines and do not necessarily meet the design guideline of other agencies such as American Bureau of Shipping, ASME Pressure Vessel Code etc. The user, through its own analysis and testing, is solely responsible for:

- Making the final selection of the cylinders and related accessories.
- Determining if the cylinders are required to meet specific design requirements as required by the Agency(s) or industry standards covering the design of the user's equipment.
- Assuring that the user's requirements are met, OSHA requirements are met, and safety guidelines from the applicable agencies such as but not limited to ANSI are followed and that the use presents no health or safety hazards.
- Providing all appropriate health and safety warnings on the equipment on which the cylinders are used.

1.5 Additional Questions – Call the appropriate Company technical service department if you have any questions or require any additional information. See the Company publication for the product being considered or used, or call the number on the back cover of this catalog for the technical service department.

2.0 Cylinder and Accessories Selection

2.1 Seals – Part of the process of selecting a cylinder is the selection of seal compounds. Before making this selection, consult the "seal information page(s)" of the publication for the series of cylinders of interest.

The application of cylinders may allow fluids such as cutting fluids, wash down fluids etc. to come in contact with the external area of the cylinder. These fluids may attack the piston rod wiper and or the primary seal and must be taken into account when selecting and specifying seal compounds.

Dynamic seals will wear. The rate of wear will depend on many operating factors. Wear can be rapid if a cylinder is mis-aligned or if the cylinder has been improperly serviced. The user must take seal wear into consideration in the application of cylinders.

2.2 Piston Rods – Possible consequences of piston rod failure or separation of the piston rod from the piston include, but are not limited to are:

- Piston rod and or attached load thrown off at high speed.
- High velocity fluid discharge.
- Piston rod extending when pressure is applied in the piston retract mode.

Piston rods or machine members attached to the piston rod may move suddenly and without warning as a consequence of other conditions occurring to the machine such as, but not limited to:

- Unexpected detachment of the machine member from the piston rod.

- Failure of the pressurized fluid delivery system (hoses, fittings, valves, pumps, compressors) which maintain cylinder position.
- Catastrophic cylinder seal failure leading to sudden loss of pressurized fluid.
- Failure of the machine control system.

Follow the recommendations of the "Piston Rod Selection Chart and Data" in the publication for the series of cylinders of interest. The suggested piston rod diameter in these charts must be followed in order to avoid piston rod buckling.

Piston rods are not normally designed to absorb bending moments or loads which are perpendicular to the axis of piston rod motion. These additional loads can cause the piston rod to fail. If these types of additional loads are expected to be imposed on the piston rod, their magnitude should be made known to our engineering department.

The cylinder user should always make sure that the piston rod is securely attached to the machine member.

On occasion cylinders are ordered with double rods (a piston rod extended from both ends of the cylinder). In some cases a stop is threaded on to one of the piston rods and used as an external stroke adjuster. On occasions spacers are attached to the machine member connected to the piston rod and also used as a stroke adjuster. In both cases the stops will create a pinch point and the user should consider appropriate use of guards. If these external stops are not perpendicular to the mating contact surface, or if debris is trapped between the contact surfaces, a bending moment will be placed on the piston rod, which can lead to piston rod failure. An external stop will also negate the effect of cushioning and will subject the piston rod to impact loading. Those two (2) conditions can cause piston rod failure. Internal stroke adjusters are available with and without cushions. The use of external stroke adjusters should be reviewed with our engineering department.

The piston rod to piston and the stud to piston rod threaded connections are secured with an anaerobic adhesive. The strength of the adhesive decreases with increasing temperature. Cylinders which can be exposed to temperatures above +250°F (+121°C) are to be ordered with a non studded piston rod and a pinned piston to rod joint.

2.3 Cushions – Cushions should be considered for cylinder applications when the piston velocity is expected to be over 4 inches/second.

Cylinder cushions are normally designed to absorb the energy of a linear applied load. A rotating mass has considerably more energy than the same mass moving in a linear mode. Cushioning for a rotating mass application should be reviewed by our engineering department.

2.4 Cylinder Mountings – Some cylinder mounting configurations may have certain limitations such as but not limited to minimum stroke for side or foot mounting cylinders or pressure de-ratings for certain mounts. Carefully review the catalog for these types of restrictions.

Always mount cylinders using the largest possible high tensile alloy steel socket head cap screws that can fit in the cylinder mounting holes and torque them to the manufacturer's recommendations for their size.

2.5 Port Fittings – Hydraulic cylinders applied with meter out or deceleration circuits are subject to intensified pressure at piston rod end.

The rod end pressure is approximately equal to:

$$\frac{\text{operating pressure} \times \text{effective cap end area}}{\text{effective rod end piston area}}$$

Contact your connector supplier for the pressure rating of individual connectors.

3.0 Cylinder and Accessories Installation and Mounting

3.1 Installation

3.1.1 – Cleanliness is an important consideration, and cylinders are shipped with the ports plugged to protect them from contaminants entering the ports. These plugs should not be removed until the piping is to be installed. Before making the connection to the cylinder ports, piping should be thoroughly cleaned to remove all chips or burrs which might have resulted from threading or flaring operations.

3.1.2 – Cylinders operating in an environment where air drying materials are present such as fast-drying chemicals, paint, or weld splatter, or other hazardous conditions such as excessive heat, should have shields installed to prevent damage to the piston rod and piston rod seals.

3.1.3 – Proper alignment of the cylinder piston rod and its mating component on the machine should be checked in both the extended and retracted positions. Improper alignment will result in excessive rod gland and/or cylinder bore wear. On fixed mounting cylinders attaching the piston rod while the rod is retracted will help in achieving proper alignment.

3.1.4 – Sometimes it may be necessary to rotate the piston rod in order to thread the piston rod into the machine member. This operation must always be done with zero pressure being applied to either side of the piston. Failure to follow this procedure may result in loosening the piston to rod-threaded connection. In some rare cases the turning of the piston rod may rotate a threaded piston rod gland and loosen it from the cylinder head. Confirm that this condition is not occurring. If it does, re-tighten the piston rod gland firmly against the cylinder head.

For double rod cylinders it is also important that when attaching or detaching the piston rod from the machine member that the torque be applied to the piston rod end of the cylinder that is directly attaching to the machine member with the opposite end unrestrained. If the design of the machine is such that only the rod end of the cylinder opposite to where the rod attaches to the machine member can be rotated, consult the factory for further instructions.

3.2 Mounting Recommendations

3.2.1 – Always mount cylinders using the largest possible high tensile alloy steel socket head screws that can fit in the cylinder mounting holes and torque them to the manufacturer's recommendations for their size.

3.2.2 – Side-Mounted Cylinders – In addition to the mounting bolts, cylinders of this type should be equipped with thrust keys or dowel pins located so as to resist the major load.

3.2.3 – Tie Rod Mounting – Cylinders with tie rod mountings are recommended for applications where mounting space is limited. The standard tie rod extension is shown as BB in dimension tables. Longer or shorter extensions can be supplied. Nuts used for this mounting style should be torqued to the same value as the tie rods for that bore size.

3.2.4 – Flange Mount Cylinders – The controlled diameter of the rod gland extension on head end flange mount cylinders can be used as a pilot to locate the cylinders in relation to the machine. After alignment has been obtained, the flanges may be drilled for pins or dowels to prevent shifting.

3.2.5 – Trunnion Mountings – Cylinders require lubricated bearing blocks with minimum bearing clearances. Bearing blocks should be carefully aligned and rigidly mounted so the trunnions will not be subjected to bending moments. The rod end should also be pivoted with the pivot pin in line and parallel to axis of the trunnion pins.

3.2.6 – Clevis Mountings – Cylinders should be pivoted at both ends with centerline of pins parallel to each other. After cylinder is mounted, be sure to check to assure that the cylinder is free to swing through its working arc without interference from other machine parts.

4.0 Cylinder and Accessories Maintenance, Troubleshooting and Replacement

4.1 Storage – At times cylinders are delivered before a customer is ready to install them and must be stored for a period of time. When storage is required the following procedures are recommended.

4.1.1 – Store the cylinders in an indoor area which has a dry, clean and noncorrosive atmosphere. Take care to protect the cylinder from both internal corrosion and external damage.

4.1.2 – Whenever possible cylinders should be stored in a vertical position (piston rod up). This will minimize corrosion due to possible condensation which could occur inside the cylinder. This will also minimize seal damage.

4.1.3 – Port protector plugs should be left in the cylinder until the time of installation.

4.1.4 – If a cylinder is stored full of hydraulic fluid, expansion of the fluid due to temperature changes must be considered. Installing a check valve with free flow out of the cylinder is one method.

4.1.5 – When cylinders are mounted on equipment that is stored outside for extended periods, exposed unpainted surfaces, e.g. piston rod, must be coated with a rust-inhibiting compound to prevent corrosion.

4.2 Cylinder Trouble Shooting

4.2.1 – External Leakage

4.2.1.1 – Rod seal leakage can generally be traced to worn or damaged seals. Examine the piston rod for dents, gouges or score marks, and replace piston rod if surface is rough.

Rod seal leakage could also be traced to gland wear. If clearance is excessive, replace rod bushing and seal. Rod seal leakage can also be traced to seal deterioration. If seals are soft or gummy or brittle, check compatibility of seal material with lubricant used if air cylinder, or operating fluid if hydraulic cylinder. Replace with seal material, which is compatible with these fluids. If the seals are hard or have lost elasticity, it is usually due to exposure to temperatures in excess of 165°F. (+74°C). Shield the cylinder from the heat source to limit temperature to 350°F. (+177°C.) and replace with fluorocarbon seals.

4.2.1.2 – Cylinder body seal leak can generally be traced to loose tie rods. Torque the tie rods to manufacturer's recommendation for that bore size.

Excessive pressure can also result in cylinder body seal leak. Determine maximum pressure to rated limits. Replace seals and retorque tie rods as in paragraph above. Excessive pressure can also result in cylinder body seal leak. Determine if the pressure rating of the cylinder has been exceeded. If so, bring the operating pressure down to the rating of the cylinder and have the tie rods replaced.

Pinched or extruded cylinder body seal will also result in a leak. Replace cylinder body seal and retorque as in paragraph above.

Cylinder body seal leakage due to loss of radial squeeze which shows up in the form of flat spots or due to wear on the O.D. or I.D. – Either of these are symptoms of normal wear due to high cycle rate or length of service. Replace seals as per paragraph above.

4.2.2 – Internal Leakage

4.2.2.1 – Piston seal leak (by-pass) 1 to 3 cubic inches per minute leakage is considered normal for piston ring construction. Virtually no static leak with lipseal type seals on piston should be expected. Piston seal wear is a usual cause of piston seal leakage. Replace seals as required.

4.2.2.2 – With lipseal type piston seals excessive back pressure due to over-adjustment of speed control valves could be a direct cause of rapid seal wear. Contamination in a hydraulic system can result in a scored cylinder bore, resulting in rapid seal wear. In either case, replace piston seals as required.

4.2.2.3 – What appears to be piston seal leak, evidenced by the fact that the cylinder drifts, is not always traceable to the piston. To make sure, it is suggested that one side of the cylinder piston be pressurized and the fluid line at the opposite port be disconnected. Observe leakage. If none is evident, seek the cause of cylinder drift in other component parts in the circuit.

4.2.3 – Cylinder Fails to Move the Load

4.2.3.1 – Pneumatic or hydraulic pressure is too low. Check the pressure at the cylinder to make sure it is to circuit requirements.

4.2.3.2 – Piston Seal Leak – Operate the valve to cycle the cylinder and observe fluid flow at valve exhaust ports at end of cylinder stroke. Replace piston seals if flow is excessive.

4.2.3.3 – Cylinder is undersized for the load – Replace cylinder with one of a larger bore size.

4.3 Erratic or Chatter Operation

4.3.1 – Excessive friction at rod gland or piston bearing due to load misalignment – Correct cylinder-to-load alignment.

4.3.2 – Cylinder sized too close to load requirements – Reduce load or install larger cylinder.

4.3.3 – Erratic operation could be traced to the difference between static and kinetic friction. Install speed control valves to provide a back pressure to control the stroke.

4.4 Cylinder Modifications, Repairs, or Failed Component – Cylinders as shipped from the factory are not to be disassembled and or modified. If cylinders require modifications, these modifications must be done at company locations or by The Company's certified facilities. The Cylinder Division Engineering Department must be notified in the event of a mechanical fracture or permanent deformation of any cylinder component (excluding seals). This includes a broken piston rod, tie rod, mounting accessory or any other cylinder component. The notification should include all operation and application details. This information will be used to provide an engineered repair that will prevent recurrence of the failure.

It is allowed to disassemble cylinders for the purpose of replacing seals or seal assemblies. However, this work must be done by strictly following all the instructions provided with the seal kits.

Offer of Sale

The items described in this document and other documents and descriptions provided by Parker Hannifin Corporation, its subsidiaries and its authorized distributors ("Seller") are hereby offered for sale at prices to be established by Seller. This offer and its acceptance by any customer ("Buyer") shall be governed by all of the following Terms and Conditions. Buyer's order for any item described in its document, when communicated to Seller verbally, or in writing, shall constitute acceptance of this offer. All goods, services or work described will be referred to as "Products".

1. Terms and Conditions. Seller's willingness to offer Products, or accept an order for Products, to or from Buyer is subject to these Terms and Conditions or any newer version of the terms and conditions found on-line at www.parker.com/saleterms/. Seller objects to any contrary or additional terms or conditions of Buyer's order or any other document issued by Buyer.

2. Price Adjustments; Payments. Prices stated on Seller's quote or other documentation offered by Seller are valid for 30 days, and do not include any sales, use, or other taxes unless specifically stated. Unless otherwise specified by Seller, all prices are F.C.A. Seller's facility (INCOTERMS 2010). Payment is subject to credit approval and is due 30 days from the date of invoice or such other term as required by Seller's Credit Department, after which Buyer shall pay interest on any unpaid invoices at the rate of 1.5% per month or the maximum allowable rate under applicable law.

3. Delivery Dates; Title and Risk; Shipment. All delivery dates are approximate and Seller shall not be responsible for any damages resulting from any delay. Regardless of the manner of shipment, title to any products and risk of loss or damage shall pass to Buyer upon placement of the products with the shipment carrier at Seller's facility. Unless otherwise stated, Seller may exercise its judgment in choosing the carrier and means of delivery. No deferment of shipment at Buyers' request beyond the respective dates indicated will be made except on terms that will indemnify, defend and hold Seller harmless against all loss and additional expense. Buyer shall be responsible for any additional shipping charges incurred by Seller due to Buyer's acts or omissions.

4. Warranty. Seller warrants that the Products sold hereunder shall be free from defects in material or workmanship for a period of eighteen months from the date of delivery to Buyer. The prices charged for Seller's products are based upon the exclusive limited warranty stated above, and upon the following disclaimer: **DISCLAIMER OF WARRANTY: THIS WARRANTY COMPRISES THE SOLE AND ENTIRE WARRANTY PERTAINING TO PRODUCTS PROVIDED HEREUNDER. SELLER DISCLAIMS ALL OTHER WARRANTIES, EXPRESS AND IMPLIED, INCLUDING DESIGN, MERCHANTABILITY AND FITNESS FOR A PARTICULAR PURPOSE.**

5. Claims; Commencement of Actions. Buyer shall promptly inspect all Products upon delivery. No claims for shortages will be allowed unless reported to the Seller within 10 days of delivery. No other claims against Seller will be allowed unless asserted in writing within 30 days after delivery. Buyer shall notify Seller of any alleged breach of warranty within 30 days after the date the defect is or should have been discovered by Buyer. Any action based upon breach of this agreement or upon any other claim arising out of this sale (other than an action by Seller for an amount due on any invoice) must be commenced within 12 months from the date of the breach without regard to the date breach is discovered.

6. LIMITATION OF LIABILITY. UPON NOTIFICATION, SELLER WILL, AT ITS OPTION, REPAIR OR REPLACE A DEFECTIVE PRODUCT, OR REFUND THE PURCHASE PRICE. IN NO EVENT SHALL SELLER BE LIABLE TO BUYER FOR ANY SPECIAL, INDIRECT, INCIDENTAL OR CONSEQUENTIAL DAMAGES ARISING OUT OF, OR AS THE RESULT OF, THE SALE, DELIVERY, NON-DELIVERY, SERVICING, USE OR LOSS OF USE OF THE PRODUCTS OR ANY PART THEREOF, OR FOR ANY CHARGES OR EXPENSES OF ANY NATURE INCURRED WITHOUT SELLER'S WRITTEN CONSENT, EVEN IF SELLER HAS BEEN NEGLIGENT, WHETHER IN CONTRACT, TORT OR OTHER LEGAL THEORY. IN NO EVENT SHALL SELLER'S LIABILITY UNDER ANY CLAIM MADE BY BUYER EXCEED THE PURCHASE PRICE OF THE PRODUCTS.

7. User Responsibility. The user, through its own analysis and testing, is solely responsible for making the final selection of the system and Product and assuring that all performance, endurance, maintenance, safety and warning requirements of the application are met. The user must analyze all aspects of the application and follow applicable industry standards and Product information. If Seller provides Product or system options, the user is responsible for determining that such data and specifications are suitable and sufficient for all applications and reasonably foreseeable uses of the Products or systems.

8. Loss to Buyer's Property. Any designs, tools, patterns, materials, drawings, confidential information or equipment furnished by Buyer or any other items which become Buyer's property, will be considered obsolete and may be destroyed by Seller after two consecutive years have elapsed without Buyer ordering the items manufactured using such property. Seller shall not be responsible for any loss or damage to such property while it is in Seller's possession or control.

9. Special Tooling. A tooling charge may be imposed for any special tooling, including without limitation, dies, fixtures, molds and patterns, acquired to manufacture Products. Such special tooling shall be and remain Seller's property notwithstanding payment of any charges by Buyer. In no event will Buyer acquire any interest in apparatus belonging to Seller which is utilized in the manufacture of the Products, even if such apparatus has been specially converted or adapted for such manufacture and notwithstanding any charges paid by Buyer. Unless otherwise agreed, Seller shall have the right to alter, discard or otherwise dispose of any special tooling or other property in its sole discretion at any time.

10. Buyer's Obligation; Rights of Seller. To secure payment of all sums due or otherwise, Seller shall retain a security interest in the goods delivered and this agreement shall be deemed a Security Agreement under the Uniform Commercial Code. Buyer authorizes Seller as its attorney to execute and file on Buyer's behalf all documents Seller deems necessary to perfect its security interest.

11. Improper use and Indemnity. Buyer shall indemnify, defend, and hold Seller harmless from any claim, liability, damages, lawsuits, and costs (including attorney fees), whether for personal injury, property damage, patent, trademark or copyright

infringement or any other claim, brought by or incurred by Buyer, Buyer's employees, or any other person, arising out of: (a) improper selection, improper application or other misuse of Products purchased by Buyer from Seller; (b) any act or omission, negligent or otherwise, of Buyer; (c) Seller's use of patterns, plans, drawings, or specifications furnished by Buyer to manufacture Product; or (d) Buyer's failure to comply with these terms and conditions. Seller shall not indemnify Buyer under any circumstance except as otherwise provided.

12. Cancellations and Changes. Orders shall not be subject to cancellation or change by Buyer for any reason, except with Seller's written consent and upon terms that will indemnify, defend and hold Seller harmless against all direct, incidental and consequential loss or damage. Seller may change product features, specifications, designs and availability with notice to Buyer.

13. Limitation on Assignment. Buyer may not assign its rights or obligations under this agreement without the prior written consent of Seller.

14. Force Majeure. Seller does not assume the risk and shall not be liable for delay or failure to perform any of Seller's obligations by reason of circumstances beyond the reasonable control of Seller (hereinafter "Events of Force Majeure"). Events of Force Majeure shall include without limitation: accidents, strikes or labor disputes, acts of any government or government agency, acts of nature, delays or failures in delivery from carriers or suppliers, shortages of materials, or any other cause beyond Seller's reasonable control.

15. Waiver and Severability. Failure to enforce any provision of this agreement will not waive that provision nor will any such failure prejudice Seller's right to enforce that provision in the future. Invalidation of any provision of this agreement by legislation or other rule of law shall not invalidate any other provision herein. The remaining provisions of this agreement will remain in full force and effect.

16. Termination. Seller may terminate this agreement for any reason and at any time by giving Buyer thirty (30) days written notice of termination. Seller may immediately terminate this agreement, in writing, if Buyer: (a) commits a breach of any provision of this agreement (b) appoints a trustee, receiver or custodian for all or any part of Buyer's property (c) files a petition for relief in bankruptcy on its own behalf, or by a third party (d) makes an assignment for the benefit of creditors, or (e) dissolves or liquidates all or a majority of its assets.

17. Governing Law. This agreement and the sale and delivery of all Products hereunder shall be deemed to have taken place in and shall be governed and construed in accordance with the laws of the State of Ohio, as applicable to contracts executed and wholly performed therein and without regard to conflicts of laws principles. Buyer irrevocably agrees and consents to the exclusive jurisdiction and venue of the courts of Cuyahoga County, Ohio with respect to any dispute, controversy or claim arising out of or relating to this agreement.

18. Indemnity for Infringement of Intellectual Property Rights. Seller shall have no liability for infringement of any patents, trademarks, copyrights, trade dress, trade secrets or similar rights except as provided in this Section. Seller will defend and indemnify Buyer against allegations of infringement of U.S. patents, U.S. trademarks, copyrights, trade dress and trade secrets ("Intellectual Property Rights"). Seller will defend at its expense and will pay the cost of any settlement or damages awarded in an action brought against Buyer based on an allegation that a Product sold pursuant to this Agreement infringes the Intellectual Property Rights of a third party. Seller's obligation to defend and indemnify Buyer is contingent on Buyer notifying Seller within ten (10) days after Buyer becomes aware of such allegations of infringement, and Seller having sole control over the defense of any allegations or actions including all negotiations for settlement or compromise. If a Product is subject to a claim that it infringes the Intellectual Property Rights of a third party, Seller may, at its sole expense and option, procure for Buyer the right to continue using the Product, replace or modify the Product so as to make it noninfringing, or offer to accept return of the Product and return the purchase price less a reasonable allowance for depreciation. Notwithstanding the foregoing, Seller shall have no liability for claims of infringement based on information provided by Buyer, or directed to Products delivered hereunder for which the designs are specified in whole or part by Buyer, or infringements resulting from the modification, combination or use in a system of any Product sold hereunder. The foregoing provisions of this Section shall constitute Seller's sole and exclusive liability and Buyer's sole and exclusive remedy for infringement of Intellectual Property Rights.

19. Entire Agreement. This agreement contains the entire agreement between the Buyer and Seller and constitutes the final, complete and exclusive expression of the terms of sale. All prior or contemporaneous written or oral agreements or negotiations with respect to the subject matter are herein merged.

20. Compliance with Law, U. K. Bribery Act and U.S. Foreign Corrupt Practices Act. Buyer agrees to comply with all applicable laws and regulations, including those of the United Kingdom and the United States of America, and of the country or countries of the Territory in which Buyer may operate, including without limitation the U. K. Bribery Act, the U.S. Foreign Corrupt Practices Act ("FCPA") and the U.S. Anti-Kickback Act (the "Anti-Kickback Act"), and agrees to indemnify and hold harmless Seller from the consequences of any violation of such provisions by Buyer, its employees or agents. Buyer acknowledges that they are familiar with the provisions of the U. K. Bribery Act, the FCPA and the Anti-Kickback Act, and certifies that Buyer will adhere to the requirements thereof. In particular, Buyer represents and agrees that Buyer shall not make any payment or give anything of value, directly or indirectly to any governmental official, any foreign political party or official thereof, any candidate for foreign political office, or any commercial entity or person, for the purpose of influencing such person to purchase products or otherwise benefit the business of Seller.

Catalog HY04-AC1138-4/NA
03/13

© Copyright 2008-2013 Parker Hannifin Corporation
All rights reserved.

ATLAS **CYLINDERS**

500 S. Wolf Rd.
Des Plaines, IL 60016
Tel.: (847) 298-2400
Fax: (800) 892-1008
atlasclmktg@parker.com
www.AtlasCylinders.com